

# PRIMA<sup>®</sup>

## Catalog Medical





**Vetro Design** este o companie cu peste douăzeci și cinci de ani de experiență profesională și peste șazeci de angajați, operând exclusiv cu capital românesc. Compania noastră este un principal importator, distribuitor și exportator de dispozitive medicale, produse de laborator, produse medico-dentare și veterinare, articole profesionale pentru industria de înfrumusețare, produse de curățenie și igienă din România.

Cu peste 10.000 de metri pătrați de spațiu de depozitare, birouri și producție, facilități de import și distribuție dedicate, Vetro Design este cel mai mare depozit de produse de unică folosință destinate domeniului sănătății din țară. În plus, echipa noastră eficientă asigură o distribuție rapidă și constantă către toți clienții din teritoriul Uniunii Europene, dar și către cei din întreaga lume.

#### **Suntem producători:**

La nivel național, suntem printre puținii **producători de truse sanitare** de prim ajutor, kituri de înlocuire, truse sanitare auto, truse de prim ajutor auto DIN 13164 (omologate la nivel internațional) și truse de urgență pentru cabinetele stomatologice. Toate produsele sunt avizate de Ministerul Sănătății și se diferențiază de cele concurente prin calitatea conținutului marca PRIMA.

**Din anul 2016 Vetro Design confecționează uniforme profesionale.** Utilizând materiale textile calitative, echipamente performante și având un personal specializat, am creat o gamă care include uniforme medicale, îmbrăcăminte de lucru pentru hoteluri și industria alimentară, uniforme pentru saloane și îmbrăcăminte de protecție. Uniformele profesionale PRIMA sunt disponibile într-o varietate de materiale, culori și modele. *Pentru că apreciam dorința clienților noștri de a fi unici, putem personaliza toate uniformele din colecția noastră prin broderie, imprimare sau serigrafie și execută modele noi pe comandă.*

#### **Oferim soluția optimă:**

Ca importator direct și producător, Vetro Design oferă prețuri competitive și cunoaște foarte bine piețele produselor sale. De asemenea, compania noastră se remarcă prin soluții de cumpărare facile, oferindu-le clienților toate produsele necesare dintr-o singură sursă, ceea ce economisește timp și bani. În plus, toate articolele noastre sunt supuse unui control strict al calității și respectă standardele Uniunii Europene.

Echipa Vetro Design este formată din persoane ambițioase și profesioniste, pregătite să îi sprijine pe clienți cu informații despre produsele din portofoliul companiei, solicitări de articole noi și promoții curente.

Pentru a ne îmbunătăți constant produsele, a avea o gamă completă de articole profesionale, dar și pentru oportunitatea de a ne cunoaște mai bine clienții, participăm în fiecare an la cele mai importante târguri și expoziții de specialitate naționale și internaționale.

#### **Mărcile noastre:**

Principalul brand al companiei, **PRIMA**, este bine cunoscut în România. Cu peste 3.000 de articole comercializate sub acest nume, marca și-a creat o imagine puternică pe piața autohtonă. Am lansat brandul **PRIMA** în anul 2003 din necesitatea de a controla nivelul de calitate promis și de a încuraja încrederea clienților în specificațiile tehnice ale produselor din oferta noastră.

Marca **VIORA** cuprinde articole și soluții de curățenie. Folosind o parte a verbului a „înviara”, numele mărcii exprima ideea de prospețime obținută ca urmare a utilizării produselor noastre.

Sub marca **ALINTA** se regăsesc produse destinate vânzării cu amănuntul. Aceasta a fost introdusă pe piața românească în anul 2007, iar numele ales ca o sugestie a beneficiilor oferite: a alina durerea, respectiv a alina consumatorul.

#### **Viziune, misiune și valori:**

**Viziunea** noastră constă în a deveni un cadru de referință pentru toate domeniile în care ne desfășurăm activitatea, creând valoare pentru clienții, partenerii, colegii și comunitatea noastră. Oferind numai produse care respectă standarde stricte de calitate, suntem permanent preocupați să atingem și să depășim așteptările clienților noștri, să fim soluția optimă și partenerul de afaceri preferat.

**Misiunea** noastră este să îi întâmpinăm pe clienții noștri cu un portofoliu complet de produse profesionale dedicate domeniilor de sănătate, înfrumusețare, igienă și curățenie. Îmbunătățind în mod continuu performanța globală a organizației, scopul nostru este de a ne apropia de nevoile și dorințele dumneavoastră, oferindu-vă produse de calitate superioară și o colaborare de încredere.

**Valorile** după care ne ghidăm activitatea zilnică sunt respectul față de clienții noștri, siguranța și gradul de inovație al produselor oferite, respectiv excelență datorată investițiilor pe care le facem în dezvoltarea companiei. La acestea se adaugă pasiunea, perseverența și integritatea unei echipe unite de profesioniști.

With over twenty-five years of professional experience and over 60 employees, **Vetro Design** is a company operating exclusively with Romanian capital. Our company is a leading importer, distributor and exporter of medical devices and laboratory products, dental and veterinary articles, professional beauty products as well as cleaning and hygiene products.

With over 10,000 square meters of storage space, offices and production, dedicated import and distribution facilities, Vetro Design is the largest warehouse for health-related single use products in the country. In addition to this, our efficient team ensures a fast and constant distribution to all of our customers in the European Union, but also to those around the world.

#### **We are manufacturers:**

At national level, we are among the few **manufacturers of first aid kits**, replacement kits, car kits, DIN 13164 first aid kits (internationally approved) and emergency kits for dental surgeries. All products are approved by the Ministry of Health and differentiate from those of the competitors due to the quality of the PRIMA brand content.

Internationally, **Vetro Design produces and sells professional uniforms**. Using only quality textiles, high performance equipment and specialized staff, we have created a range that includes medical uniforms, work clothing for hotels and the food industry, uniforms for salons and protective clothing.

Professional PRIMA Uniforms are available in a variety of materials, colors and designs. Because we appreciate our clients' desire to be unique, all the uniforms in our collection can be personalised with embroidery, printing or screen printing. We also offer tailored designs.

#### **We offer the optimal solution:**

As a direct importer and manufacturer, Vetro Design offers competitive prices and knows its product markets very well. Our company stands out due to the easy buying process which provides customers with all necessary products from a single source, saving them time and money. Additionally, all our articles are subject to a strict quality control and comply with the European Union standards.

The Vetro Design team comprises ambitious and professional individuals, ready to support customers with all relevant information about the company's products, new article requests and current promotions.

In order for us to constantly improve our products, to have a full range of professional articles and for the opportunity to know our customers better, every year we take part in the most important national and international trade fairs and exhibitions.

#### **Our brands:**

Because of our need to control the promised quality level and to encourage customer confidence in the technical specifications of our products, in 2003 we created **PRIMA** – the main brand of our company. With over 3,000 articles sold under this name, the brand has rapidly grown and is now well known in Romania.

Our second brand, **VIORA**, extends over a range of cleaning articles and solutions. The brand name expresses the idea of freshness obtained from the use of our products.

The brand **ALINTA** includes retail products. It was introduced to the Romanian market in 2007 and the name was chosen as a suggestion of the benefits offered: to alleviate pain, to comfort the client.

#### **Vision, mission and values:**

**Our vision** is to become a benchmark in all our lines of work, creating value for our customers, partners, colleagues and our community. By only offering products that meet strict quality standards, we are constantly concerned to reach and exceed our customers' expectations, to be the optimal solution and the preferred business partner.

**Our mission** is to meet our customers with a complete portfolio of professional products dedicated to health, beauty, hygiene and cleanliness. By continuously improving our organization's overall performance, our goal is to understand our customers needs and desires, delivering superior quality products and a trusting collaboration.

**The values** we guide our day to day activity by are the respect for our customers, the safety and the degree of innovation of the products offered, and the overall excellence deriving from the investments we make in the company's development. To these we add the passion, perseverance and integrity of a team of professionals.



Medical cabinet

Medical laborator

Sterilizare și dezinfecțanți

1-68

69-74

75-87

## CUPRINS

<b>Aparate control sănătate</b>	<b>1-3</b>		
- Controlul temperaturii	1		
- Controlul tensiunii & pulsului	2, 2		
- Controlul glicemiei	2		
- Lanțete recoltare	3		
- Garouri	3		
- Pungi farmacie	3		
<b>Aparatură medicală</b>	<b>4-7</b>		
- Unitate tracțiuni lombare	4		
- Lampă ultraviolete	5		
- Dermatoscop	5		
- Microscop biologic	5		
- Nebulizatoare	6		
- Instrumentar laborator	7		
<b>Mănuși examinare și chirurgicale</b>	<b>8-9</b>		
- Mănuși examinare latex	8		
- Mănuși examinare nitril	8		
- Mănuși examinare cu aloe vera	9		
- Mănuși chirurgicale sterile	9		
- Mănuși examinare vinil	9		
<b>Chirurgie</b>	<b>10-15</b>		
- Câmpuri chirurgicale sterile	10		
- Seturi chirurgicale	11, 12		
- Produse medicale diverse	12		
- Halate chirurgicale sterile	13		
- Halate, pantaloni și combinezoane	13		
- Plase chirurgicale	13		
- Substitut osos	14		
- Membrană, bureți collagen	14		
- Capsatoare chirurgicale piele	15		
- Pense plastic	15		
<b>Suturi chirurgicale</b>	<b>16-18</b>		
<b>Instrumentar chirurgical</b>	<b>19-22</b>		
- Foarfeci	19		
- Ace chirurgicale	19		
- Ață chirurgicală	19		
- Port ac suturi chirurgicale	19		
- Instrumentar chirurgical	20, 21, 22		
<b>Lame de bisturiu, electrocautere</b>	<b>23-25</b>		
- Lame bisturiu	23, 24		
- Electrocautere	24, 25		
<b>Seringi și ace seringă</b>	<b>26-28</b>		
- Seringi insulină	26		
- Seringi Luer Slip	26		
- Seringi Luer lock	27		
- Seringi Guyon	27		
- Ace seringă	27		
- Ace spinale	28		
- Distrugător ace	28		
<b>Truse perfuzie, branule, microperfuzoare</b>	<b>29-30</b>		
- Truse perfuzie	29		
- Truse transfuzie sânge	29		
- Robineți perfuzie 3 căi	29		
- Microperfuzoare și adaptoare	30		
- Branule cu valvă și cateter F.E.P	30		
<b>Comprese, feși, bandaje</b>	<b>31-37</b>		
- Fașe tifon bumbac	31		
- Comprese tifon nesterile	31		
- Comprese tifon sterile tăiate	31		
- Comprese tifon sterile pliate	32		
- Comprese neșesut	32		
- Comprese neșesut cu alcool	32		
- Tampoane din celuloză	32		
- Bandaje elastice	33		
- Produse pentru arsuri	34		
- Comprese tifon pliate	35		
- Fașe elastice de fixare	36		
- Bandaje elastice	36		
- Benzi kinesiologice	36		
- Fașe tifon ghipsate	37		
- Vată ortopedică	37		
- Accesorii imobilizare	37		
<b>Cosmetică facială</b>	<b>38</b>		
- Bețișoare bumbac ALINTA	38		
- Dischete și bile bumbac	38		
- Pudră de talc	38		
<b>Leucoplast, plasturi</b>	<b>39-41</b>		
- Plasturi pentru branule	39		
- Plasturi medicali ALINTA	39		
- Leucoplast medical	40		
- Plasturi medicali	40, 41		
- Plasturi medicali sterili	41		
<b>Consumabile ECG, EKG, ECO</b>	<b>42-49</b>		
- Gel EKG-ECO	42		
- Gel lubrifiant	42		
- Hârtie ECG în rolă	43, 44		
- Hârtie ECG în Z	45		
- Acumulatori ECG	46		
- Electrozi	47		
- Cabluri EKG	48		
- Hârtie video printere	49		
<b>Spirometrie</b>	<b>50</b>		
- Piese de gură	50		
- Hârtie spirometrie și audiometrie	50		
<b>Radioprotecție</b>	<b>51</b>		
<b>Ginecologie</b>	<b>52-54</b>		
- Speculum vaginal	52		
- Periuțe și spatule Ayre de recoltare	52		
- Contracepție	53		
- Teste sarcină și ovulație	53		
- Produse proctologie	53		
- Canule rectale	53		
- Obstetrică-ginecologie chirurgie	54		
- Benzi de identificare	54		
- Port ac suturi chirurgicale	54		
<b>Prim ajutor, respirație</b>	<b>55-58</b>		
- Resuscitare	55		
- Pipe Berman & Guedel	56		
- Prim ajutor resuscitare	56		
- Administrare oxigen	56		
- Forcepsuri	57		
- Laringoscop	57		
- Sonde Foley uretrale	58		
- Sonde alimentație	58		
- Sonde bazo-gastrice Levin	58		
<b>Administrare alimente</b>	<b>58</b>		
<b>Îngrijire persoane imobilizate</b>	<b>59-61</b>		
- Scutece și cearceafuri incontinență adulți	59		
- Ploscă, urinar	60		
- Produse persoane imobilizate	61		
<b>Unică folosință neșesut</b>	<b>62-63</b>		
- Bonete neșesut	62		
- Măști medicale	62		
- Halate, pantaloni și combinezoane	63		
<b>Protecție pat</b>	<b>64-66</b>		
- Lenjerie de pat de unică folosință	64, 65		
- Cearceafuri pat hârtie	64		
- Mușama pat cauciuc	65		
- Cearceafuri pat hârtie și PE impermeabilă	66		
<b>Papuci unică folosință</b>	<b>66</b>		
<b>Deșeuri infecțioase</b>	<b>67-68</b>		
- Cutii și saci	67, 68		
- Recipienti deșeuri tăietoare înțepătoare	67		
- Saci autoclavabili pentru deșeuri medicale	68		
<b>Consumabile laborator</b>	<b>69-73</b>		
- Exudat faringian	69		
- Spatule lemn	69		
- Lame și lamele microscop	69		
- Cutii Petri	70		
- Anatomie patologică	70		
- Recipienti recoltare medicală	70		
- Instrumentar laborator	71		
- Tuburi colectare sânge	72, 73		
- Ace vacutainer	73		
- Consumabile afecțiuni oculare	73		
<b>Teste rapide</b>	<b>74</b>		
<b>Spirit și soluții dezinfectante</b>	<b>75</b>		
<b>Sterilizare</b>	<b>76-79</b>		
- Indicatori și accesorii sterilizare	76, 77		
- Pungi autosigilante	77		
- Pungi în rolă	78		
- Pliu în rolă	78		
- Hârtie creponată	78		
- Pungi autosigilante nylon-pupinel	79		
- Sterilizatoare	79		
<b>Cutii și tăvițe instrumentar</b>	<b>80-81</b>		
- Tăvițe medicale	80		
- Cutii și caserole	80, 81		
<b>Aparatură Sterilizare</b>	<b>82</b>		
- Aspirator chirurgical portabil	82		
<b>Dezinfectanți</b>	<b>83-85</b>		
- Pompă dozaj flacon	83		
- Apă distilată	83		
- Dezinfectanți suprafețe	84		
- Dezinfectant instrumente	85		
- Dezinfectant și detergenți suprafețe	85		
- Dezinfectant mâini și piele	85		
<b>Covoare de decontaminare</b>	<b>86</b>		
<b>Defibrilator automat</b>	<b>87</b>		



**Medical practice**

1-68

**Medical laboratory**

69-74

**Sterilization & disinfectants**

75-87

## TABLE OF CONTENTS

<b>Examination devices</b>	<b>1-1</b>		
- Temperature control	1		
- Pulse & bloodpressure control	1, 2		
- Glycemic control	2		
- Blood lancets	3		
- Tourniquets	3		
- Pharmacy bags	3		
<b>Medical equipment</b>	<b>4-7</b>		
- Lumbar Traction Unit	4		
- Ultraviolet Lamp	5		
- Dermatoscope	5		
- Biological Microscope	5		
- Nebulizers	6		
- Laboratory instruments	7		
<b>Examination and surgical gloves</b>	<b>8-9</b>		
- Latex examination gloves	8		
- Nitril examination gloves	8		
- Aloe vera examination gloves	9		
- Sterile surgical latex gloves	9		
- Vinyl examination gloves	9		
<b>Surgery</b>	<b>10-15</b>		
- Sterile surgical drapes	10		
- Sterile adhesive surgical drapes	15		
- Surgical sets	11, 12		
- Medical Products-Other supplies	12		
- Sterile surgical gowns	13		
- Gowns, trousers and coveralls	13		
- Surgical meshes	13		
- Synthetic bone graft substitute	14		
- Collagen membranes and sponges	14		
- Surgical skin staples	15		
- Plastic forceps	15		
<b>Surgical sutures</b>	<b>16-18</b>		
<b>Surgical instruments</b>	<b>19-22</b>		
- Scissors	19		
- Surgical needle	19		
- Surgical thread	19		
- Surgical needle holders	19		
- Surgical instruments	20, 21, 22		
<b>Scalpel blades, electrocautery devices</b>	<b>23-25</b>		
- Surgical blades	23, 24		
- Electrocauters	24, 25		
<b>Syringes and syringe needles</b>	<b>26-28</b>		
- Insuline syringe	26		
- Luer Slip syringe	26		
- Luer lock syringe	27		
- Guyon Syringe	27		
- Syringe needles	27		
- Spinal needles	28		
- Needle destroyer	28		
<b>Infusion sets, I.V. Cannulas, scalp vein sets</b>	<b>29-30</b>		
- Infusion sets	29		
- Blood transfusion kits	29		
- 3 way stop cock	29		
- Scalp veins and adaptors	30		
- I.V. Cannula w/F.E.P catheter and valve	30		
<b>Gauze swabs and bandages</b>	<b>31-37</b>		
- Cotton gauze bandages	31		
- Cotton gauze non-sterile	31		
- Sterile cotton gauze	31, 32		
- Nonwoven gauzes	32		
- Nonwoven pads w/ alcohol	32		
- Cellulose Pads	32		
- Elastic bandages	33		
- Burning care products	34		
- Cotton gauze	35		
- Elastic fixation bandages	36		
- Elastic bandages	36		
- Kinesiology tapes	36		
- Gypsum gauze bandage	37		
- Accessories	37		
- Immobilization accessories	37		
<b>Facial cosmetics</b>	<b>38</b>		
- Cotton buds ALINTA Cotton pads and balls	38		
- Talcum powder	38		
<b>Medical adhesive tape, plasters</b>	<b>39-41</b>		
- Plasters for cannulas	39		
- ALINTA plasters	39		
- Medical adhesive tapes	40		
- First aid plasters	40, 41		
- Sterile first aid plasters	41		
<b>ECG, EKG, ECO consumables</b>	<b>42-49</b>		
- ECO gel 52 Lubricant gel	42		
		- ECG paper in rolls	43, 44
		- ECG paper in Z	45
		- ECG batteries	46
		- Electrodes	47
		- EKG cables	48
		- Thermal paper for video printers	49
		<b>Spirometry</b>	<b>50</b>
		- Mouthpieces	50
		- Spirometry and audiometry paper	50
		<b>X-Ray protection</b>	<b>51</b>
		<b>Gynecology</b>	<b>52-54</b>
		- Vaginal speculum	52
		- Scrapers and Ayre spatula for probes	52
		- Contraception	53
		- Pregnancy and ovulation tests	53
		- Proctology products	53
		- Rectal cannulas	53
		- Obstetrics-Gynecology surgery	54
		- Identification bracelets	54
		- Surgical needle holders	54
		<b>First aid, breathing</b>	<b>55-57</b>
		- Resuscitation	55
		- Berman and Guedel airway	56
		- First aid breathing resuscitation	56
		- Oxygene supplying	56
		- Forcepses	57
		- Laryngoscope	57
		<b>Food administration</b>	<b>58</b>
		- Foley catheter	58
		- Feeding tubes	58
		- Levin nasi-gastric tubes	58
		<b>Immobilized patients care</b>	<b>59-61</b>
		- Incontinence adult diapers and under pads	59
		- Flask, urinary container	60
		- Immobilized patients care	61
		<b>Disposable nonwoven supplies</b>	<b>62-63</b>
		- Nonwoven caps	62
		- Medical masks	62
		- Gowns, trousers and coveralls	63
		<b>Bed protection</b>	<b>64-66</b>
		- Disposable bed cover	64, 65
		- Paper bed covers	64
		- Rubber bed cover	65
		- Paper and PE impermeable bed sheets	66
		<b>Slippers, disposable</b>	<b>66</b>
		<b>Infectious waste</b>	<b>67-68</b>
		- Medical waste bags	67, 68
		- Cremation recipients for medical waste	67
		- Garbage bags for medical waste	68
		<b>Laboratory supplies</b>	<b>69-73</b>
		- Sterile swabs	69
		- Tongue depressors	69
		- Microscope slides and covers	69
		- Petri dishes	70
		- Anatomical pathology	70
		- Recipients for medical samples	70
		- Laboratory instruments	71
		- Vacuum blood collection tubes	72, 73
		- Vacuum blood collection needles	74
		- Products for ophthalmology	73
		<b>Rapid tests</b>	<b>74</b>
		<b>Alcohol and disinfectants</b>	<b>75</b>
		<b>Sterilization</b>	<b>76-79</b>
		- Tests and accessories	76, 77
		- Self-sealed pouches	77
		- Flat reels	78
		- Gussetted reels	78
		- Nylon-self sealed bags-dry heat	79
		- Sterilizers	79
		<b>Boxes, tools, trays</b>	<b>80-81</b>
		- Medical trays	80
		- Medical boxes and drums	80, 81
		<b>Aparatură Sterilizare</b>	<b>82</b>
		- Portable suction unit	82
		<b>Disinfectants</b>	<b>83-85</b>
		- Surface disinfectants	83
		- Instrument disinfectant	85
		- Disinfectant wet tissues	82, 83
		- Distilled water	83
		- Dosage pump for flacons	83
		- Surface disinfectants and detergents	84
		- Hands and skin disinfectants	85
		<b>Decontamination mats</b>	<b>86</b>
		<b>Defibrillator</b>	<b>87</b>



**Termometru digital**

• Cu vârf flexibil pentru copii, broscuță, în cutie de plastic

**Digital thermometer**

• With flexible tip in plastic box, for kids, frog shape

36 1116 -COP



**Termometru digital**

• Cu vârf standard, în cutie plastic

**Digital thermometer**

• With standart tip, in plastic box

36 1116 -STD



**Termometru digital**

• Cu vârf standard model mercur, în cutie plastic

**Digital thermometer**

• With standart tip in plastic box

36 1116 -MRC



**Termometru digital**

• Cu vârf flexibil, în cutie plastic

**Digital thermometer**

• With flexible tip, in plastic box

36 1116 -FLX



**Termometru digital**

• Cu infraroșu, pentru măsurarea temperaturii la nivelul canalului auditiv (ureche)  
• După indicațiile medicului

**Digital thermometer**

• With infrared for measuring temperature at the auditiv level (ear canal)  
• See doctor recomandation

36 1116 -EAR



**Termometru digital**

• Cu infraroșu, pentru măsurarea temperaturii la nivelul pielii (tâmplă)  
• După indicațiile medicului

**Digital thermometer**

• With infrared for measuring temperature at the skin level (forehead)  
• See doctor recomandation

36 1116 -FRH



**Termometru cu senzori cu infraroșu IT-122**

• Fără atingere, distanță măsurare 5-15 cm  
• Pentru măsurarea temperaturii corpului la nivelul tâmpiei, ecran LCD  
**Non-contact forehead thermometer IT-122**  
• Effective distance 5-15 cm  
• For measuring temperature at the skin level (forehead), LCD display

5 2083



**Stetoscop Dual Head**

• Pentru adulți

**Stethoscope Dual Head**

• For adults

100 0856



**Stetoscop Sprague-Rappaport**

• Pentru adulți și copii

**Stethoscope Sprague-Rappaport**

• For adults and children

24 0857



**Tensiometru manual de braț, cu manometru** 48 0858

• Fără stetoscop

**Manual blood pressure unit, for upper arm**

• Without stethoscope

**Tensiometru electronic de braț** 24 0862

• Display digital cu baterii, 90 memorii

**Electronic blood pressure monitor**

• Digital display with battery, 90 memories



**Pulsoximetru de deget** 10 1787

• Color, pentru SpO2 și PULS

**Fingertip pulse oximeter**

• Color, for SpO2 and PULS



**Glucometru 0.1 ml sânge** 24 0867

• Husa, rezultate în 5 secunde (fără consumabile, dispozitiv de înțepat, ghid de referință, jurnal, geantă)

**Glucose monitoring system, 0.1 ml blood, 5 seconds results**

• 10 test strips, control solution, lancing device, 10 lancets, reference guide, logbook, carrying bag.



50 buc/pcs

**Teste glicemie cu dispozitiv de calibrare** 24 0868

**Blood glucose test strips**



**Soluție de control pentru glucometru** 30 1729

• Pentru autotestarea glucometrului

**Control Solution for Glucose Monitoring System**

• For glucose monitoring system test



Lanțete twist-one recoltare sânge

100 1010

- Asigură o măsurare fină și o recoltare de mostră prin tăierea oblică fără durere.
- Are un design universal care se potrivește cu toate dispozitivele de lanțet.
- Sterile

Twist-one blood lancets

- Fine gauge, tri-bevel tip, painless blood samplings. Consistent depth penetration. Universal design that fits almost all lancing devices.
- Sterile

G074 Garouri • Tourniquets



50 x 2,5 x 0,05 cm  
latex free

2500 0934-CAU

Garou, cauciuc sintetic  
Band blood stopper, synthesize rubber



45 cm

100 0934-TEX

Garou cu bandă elastică textilă și  
cataramă cu click  
Plastic buckle tourniquet, with textile  
elastic band



100 0934-SNU

Garou cu șnur elastic și mecanism cu  
deblocare rapidă, pentru diametre mici  
Rope Tourniquet with quick release  
locking device, for small diameters

G113 Pungi Farmacie • Pharmacy Bags



XS - 7 x 12 cm  
5000 buc / pcs

S - 9 x 15 cm  
3000 buc / pcs

M - 12 x 18 cm  
2000 buc / pcs

L - 16 x 27 cm  
1000 buc / pcs



Pungă farmacie  
Pharmacy paper bag

1 0773

Unitate HT pentru tracțiuni lombare 1860  
 HT Unit for lumbar/cervical traction

# Tracțiuni Lombare și Cervicale



**Canapea cu 3 secțiuni**  
**Arm type support**

1878

Pedală de picior, două hamuri pelviene, două hamuri lombare, ham din piele pentru cap, două bare de distribuție a tracțiunii, trei perne de mărimi diferite.

Foot pedal, two pelvic harnesses, two lumbar harnesses, leather head halter, two traction spreader bars, three differently sized cushions.

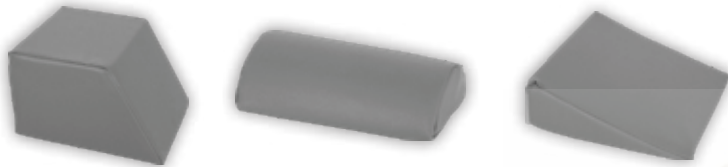

**Ham din piele pentru cap**  
**Leather head halter**

1876



**Bară de distribuție a tracțiunii**  
**Traction spreader bar**

1877



**Suport tip braț**  
**Stand for cervical traction**

1861



**i** Unitatea de tracțiune lombară și cervicală oferă o soluție inovatoare de tratare cu succes a afecțiunilor lombare și cervicale, a bolilor degenerative de disc, sau a herniei de disc prin decompresia coloanei vertebrale. Presiunea dintre vertebre se scade treptat, efectul fiind creșterea irigației sanguine și implicit a oxigenului în structurile locale, conducând la calmarea imediată a durerii și pe termen lung la îmbunătășirea stării generale a coloanei vertebrale.

**i** The lumbar and cervical traction unit offers an innovative solution for the successful treatment of lumbar and cervical disorders, diseases disk degenerative, or disc herniation by column decompression spine. The pressure between the vertebrae decreases gradually, the effect being increased blood supply and implicitly oxygen in local structures, leading to immediate pain relief and long term to improvement of the general condition of the spine.

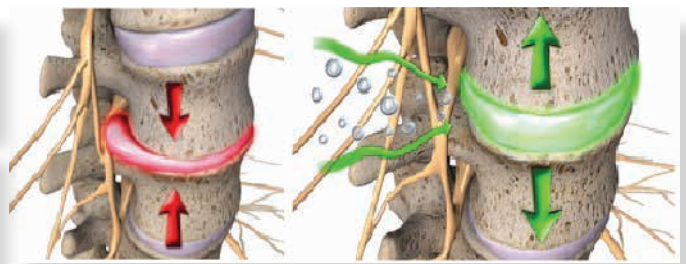





**Caracteristici:**

Pielea sănătoasă a capului și a părului sub lampa wood ar trebui să pară albă și violet cenușiu. Unghia ar trebui să pară alb strălucitor. Dacă vă îndoiți de modificărilor cosmetice, puteți pune cosmeticele anterioare și actuale sub lampa Wood pentru verificare. Aceeași formulă cosmetică ar trebui să aibă aceeași culoare.

**Characteristics:**

The healthy skin on head and hair under wood lamp should appear white and grey purple. The nail should appear bright white. If you doubt that the formula of cosmetic changes, you can put the previous and current cosmetic under the wood lamp for checking. The same formula of cosmetic should appear the same color.



30x21x7 cm

### Lampa Wood cu ultraviolete

1 2190

• Utilizată în dermatologie pentru afecțiuni ale pielii

#### Ultraviolet light lamp

• For skin condition analysis



**Caracteristici:**

- lumină halogenă pentru culoarea adevărată a țesuturilor
- placă gradată de contact cu pielea pentru a măsura leziunile pielii pigmentate
- mărire semnificativă de 10 ori
- gamă focală +/-5D (corecție)
- distanță focală 25mm
- plăci de contact autoclavabile

**Characteristics:**

- Halogen Light for true tissue color
- graduated skin contact plate to measure pigmented skin lesions.
- significant 10X magnifications.
- this product has focal range +/- 5D (correction).
- focal length is 25mm.
- autoclavable contact plates



### Dermoscop cu bec de halogen

1 2191

• Cu putere de mărire de până la 10 ori, pentru evaluarea pigmentărilor pielii, Ø25 mm, 2 plăci de contact

#### Dermoscope with halogen bulb

• With magnification power up to 10 times, for evaluating skin pigmentation, Ø25 mm, 2 contact plates



**Caracteristici:**

- sistem optic infinit
- ocular cu câmp larg WF 10X / 20
- obiective acromatice semi-plan infinite 4X, 10X, 40X, 100X
- condensator Abbe
- straturi duble (dimensiune: 150x139 mm, raza de deplasare 75x52 mm)
- luminozitate reglabilă

**Main features:**

- infinite optical system
- wide field eyepiece WF 10X/20
- infinite semi-plan achromatic objectives 4X, 10X, 40X, 100X
- Abbe condenser
- backward quadruple nosepiece
- double layers mechanical stage (size: 150x139 mm, move range 75x52 mm)
- adjustable brightness

### Microscop biologic profesional

1 2192

• Binocular, permite atașarea camerei video, 40x - 1000x

#### Professional biological microscope

• Binocular, allows the attachment of the video camera, 40x - 1000x





**Nebulizator cu compresor**

• Pentru terapia cu aerosoli, conține nebulizator cu piston, mască pentru adulți, mască pentru copii, recipient pentru medicație, adaptor pentru gură, filtru de aer, racord pentru aer, 1.33 kg

**Nebulizer with compressor**

• For aerosol therapy, contains piston nebulizer, adult mask, children's mask, medication container, mouth adapter, air filter, air connection, 1.33 kg

12 2317



90x125x145mm



**Nebulizator cu compresor**

• Pentru terapia cu aerosoli, cu capac din sticlă, conține nebulizator cu piston, mască pentru adulți, mască pentru copii, 5 filtre de aer, adaptor pentru gură, filtru de aer, racord pentru aer, 1.7 kg

**Nebulizer with compressor**

• With aerosol therapy compressor, with glass cover, contains piston nebulizer, adult mask, children's mask, 5 air filters, mouth adapter, air filter, air connection, 1.7 kg

12 2315



280x190x100mm



Este usor de utilizat, putand fi folosit cu usurinta pentru dezinfectia si igienizarea diferitelor spatii : cabinete medicale, institutii publice, birouri , restaurante etc.

It is easy to use, and can be easily used for disinfection and sanitation of various spaces: medical offices, public institutions, offices, restaurants, etc

**Nebulizator electric pentru dezinfectie ULV**

• Capacitate rezervor 5L, greutate 4.5 kg

**Electric nebulizer for ULV disinfection**

• Tank capacity 5L, weight 4.5 kg

1 2410



52 x 25 x 36 cm



90x125x145mm



Este un instrument ideal de măsurare a analizei pentru încălzirea și amestecarea lichidului, având abilitatea de a controla automat temperatura constantă.

It is an ideal tool for measuring analysis for heating and mixing the liquid, with the ability to automatically keep constant temperature.

**Caracteristici tehnice / technical specifications:**

- Sursa de alimentare / power source: 220V ± 10% 50Hz ± 2%
- Viteza rotativă / rotary speed: 0 ~ 2000r / min
- Puterea rotativă / rotary power: 40W
- Putere de încălzire / heating power: <250W
- Gama de temperatură controlată / range of controlled temperature: RT-100 C ± 1 C

**Agitator magnetic cu temperatură constantă**

10 2329

- Cu termometru digital, 25W putere de agitare

**Constant temperature magnetic stirrer**

- digital thermostat, stirring power 25W

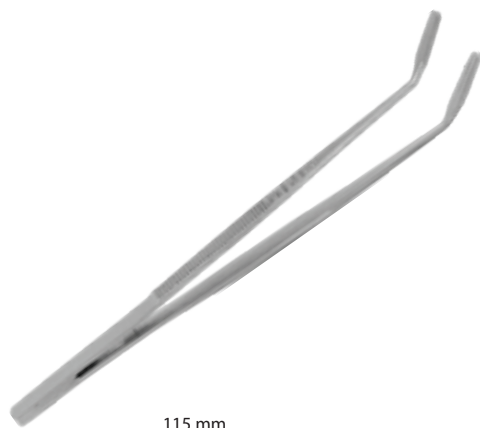

115 mm

**Pensetă pentru lamele și membrane**

10 2208

- Oțel inoxidabil

**Ultraviolet light lamp**

- Stainless steel

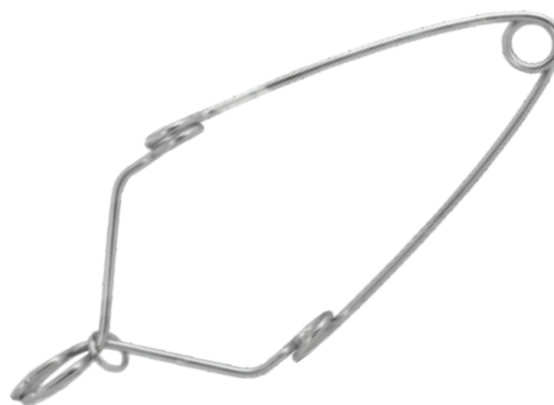
**Clește pentru eprubete**

10 2209

- Pentru eprubete cu diametru cuprins între 6 și 32 mm

**Tester pliers**

- For test tubes with a diameter between 6 and 32 mm

**Inel metalic închis cu mufă**

10 2210

- Diametru 75mm, 100mm

**Closed metal ring with plug**

- Diameter 75 mm, 100 mm

**Inel metalic deschis cu mufă**

10 2211

- Diametru 80mm

**Open metal ring with plug**

- Diameter 80mm



100 buc / pcs  
XS, S, M, L, XL

Mănuși examinare latex, albe, ușor pudrate 10 0154  
Latex examination gloves, white, lightly powdered



100 buc / pcs  
XS, S, M, L, XL

Mănuși examinare latex, albe, nepudrate 10 0155  
Latex examination gloves, white, powder free



100 buc / pcs  
XS, S, M, L, XL

Mănuși examinare nitril, albastre, ușor pudrate 10 0660  
Nitril examination gloves, blue, lightly powdered



100 buc / pcs  
XS, S, M, L, XL

Mănuși examinare nitril, albastre, nepudrate 10 0727  
Nitril examination gloves, blue, powder free



100 buc / pcs  
XS, S, M, L, XL

Mănuși examinare nitril, roz, nepudrate 10 0766  
Nitril examination gloves, pink, powder free



100 buc / pcs  
XS, S, M, L, XL

Mănuși examinare nitril, negre, nepudrate 10 1229  
Nitril examination gloves, black, powder free



100 buc / pcs  
XS, S, M, L,

Mănuși examinare latex, Aloe Vera, nepudrate  
Latex examination gloves, Aloe Vera, powder free

10 0830



100 buc / pcs  
XS, S, M, L,

Mănuși examinare nitril, Aloe Vera, nepudrate

Nitril examination gloves, Aloe Vera, powder free

10 1280



2 buc / pcs  
60 - 65 - 7 - 75 - 8 - 85

Manuși chirurgicale ușor pudrate  
• Sterile  
Latex surgical gloves, lightly powered  
• Sterile

500 0158



2 buc / pcs  
60 - 65 - 7 - 75 - 8 - 85

Manuși chirurgicale nepudrate  
• Sterile  
Latex surgical gloves, powder free  
• Sterile

500 0159



100 buc / pcs  
S, M, L,

Mănuși examinare vinil, transparente,  
ușor pudrate

Vinyl examination gloves, transparent, lightly powdered

10 0157-TRS



100 buc / pcs  
S, M, L,

Mănuși examinare vinil, albastre, ușor  
pudrate

Nitril examination gloves, blue, powder Free

10 0157-ABS



PPSB + PE

38 x 45 cm 350      75 x 90 cm 200  
 45 x 75 cm 200      100 x 150 cm 120      150 x 20 cm 100

### Câmp operator steril două straturi

0892

- Utilizat în bloc operator, cabinete stomatologice, intervenții mică chirurgie.
- Se aplică pe zone de intervenție, cu stratul nețesut în exterior, ceea ce asigură o bună absorbție a fluidelor.
- Câmpul operator este condiționat în ambalaj individual steril, barieră microbiană, strat absorbant pentru fluide.
- Steril

#### Steril surgical drape with two layers

- Used in the operating unit, dental offices, small surgical interventions.
- Apply on to the intervention area, with the non-woven layer facing towards the exterior, this providing a good absorption of fluids.
- The operating field is conditioned in an individual sterile package, microbial barrier, absorbent layer for fluids.
- Sterile



230 x 350 cm



### Câmp steril ranforsat angiografie arteră radială

100 2218

- cu doua orificii excentrice cu adeziv de 7x5 cm, doua zone cu adeziv pentru artera femurala de 16x16 cm, orificiu de 12,5 cm și zona de incizie deschisa cu diametru de 7,5 cm

#### Sterile field reinforced radial artery angiography

- with two eccentric holes with adhesive of 7 x 5 cm, two areas with adhesive for femoral artery of 16 x 16 cm, hole of 12.5 cm and open incision area with a diameter of 7.5 cm



9.5 cm

### Clemă Backhaus

10 1775

- Pentru prinderea câmpurilor operatorii.
- Inox

#### Backhaus forceps

- Towel forceps
- Stainless Steel



PPSB + PE  
2 straturi / sheets

75 x 90 cm

### Câmp operator, adeziv cu orificiu de 7 cm Adhesive surgical drape with 7 cm window

200 1175



PPSB + PE  
2 straturi / sheets

1178

### Câmp operator steril adeziv

- Steril

#### Sterile adhesive drape

- Sterile

45 x 75 cm 20

75 x 90 cm 20

10 0130-CG2

**Set universal chirurgie generală**

- Componente: 1 câmp pentru masă Mayo, 79 x 145 cm, două câmpuri adezive 90 x 75 cm, 2 prosoape absorbante 19 x 25 cm, 1 bandă adezivă 9 x 49 cm, 1 câmp adeziv 175 x 175 cm, 1 câmp adeziv 240 x 150 cm, 1 câmp pentru masă 150 x 190 cm.
- Steril

**Universal general surgery set**

- Componentă: 1 surgical Mayo table cover 79 x 145 cm, 2 adhesive surgical drape 90 x 75 cm, 2 absorbent towel 19 x 25 cm, 1 adhesive tape 9 x 49 cm, 1 adhesive surgical drape 175 x 175 cm, 1 adhesive surgical drape 240 x 150 cm, 1 surgical table cover 150 x 190 cm.
- Sterile

**Kit pansament steril, de unică folosință** 50 1422

- Componente: Pensă plastic 12.7 cm; Compresă PPSB 3 cm; tăviță de lucru cu 4 compartimente 15 x 13 x 2 cm - 1 set.
- Steril

**Sterile dressing kit, disposable**

- Components: Plastic Forceps 12.7 cm; Nonwoven Gauze ball 3 cm; In working tray with 4 compartments 15 x 13 x 2 cm - 1 set.
- Sterile

**Sistem drenaj post-operator**

- Cu recipient Redon 200 ml, tub aspirație CH14, transparent

25 1826

**Surgical sterile knee arthroscopy kit**

- With 200 ml Redon container, suction tube CH14, transparent

**Trusă mică chirurgie, suturi** 20 1212-SUT

- Componente: Câmp steril impermeabil 50 cm x 50 cm - 1 buc; Pensă plastic - 1 buc; Comprese tifon pliate 5 x 5 cm - 2 buc; Bisturiu + lamă bisturiu nr 10 - 1 buc; Tăviță compartimentată plastic - 1 buc.
- Sterilă

**Minor surgery kit, sutures**

- Components: Waterproof sterile field 50 cm x 50 cm - 1 pc; Plastic forceps - 1 pc; Cotton Gauze Swabs folded 5 x 5 pcs; Blade + surgical blade nr 10 - 1 pc; Compartmentalized plastic tray - 1 pc.
- Sterile

**Trusă mică chirurgie, cateter** 20 1212-CAT

- Componente: Cutie plastic compartimentată - 1 buc; Câmp steril impermeabil 60 cm x 60 cm - 1 buc; Câmp steril impermeabil 60 x 50 cm - 1 buc; Mănuși latex nepudrate mărimea M - 1 buc; Pensă plastic unică folosință - 1 buc; Tăviță renală - 1 buc; Tampon tifon - 5 buc; Comprese sterile 7,5 x 7,5 cm - 2 buc
- Sterilă

**Minor surgery kit, catheter**

- Components: Compartmentalized plastic box - 1 pc; Waterproof sterile field 60 cm x 60 cm - 1 pc; Waterproof sterile field 60 cm x 50 cm - 1 pc; Latex Gloves Powder Free size M - 1 pc; Disposable plastic forceps - 1 pc; Kidney tray - 1 pc; Gauze pads - 5 pcs; Sterile gauzes 7,5 x 7,5 cm - pcs
- Sterile



30 buc / pcs

culoarea pielii, cu protector cutanat atașat de sacul colector, diametru minim 20mm, decupabil maxim 64mm  
 skin color, with skin protector attached to the collection bag, minimum diameter 20mm, maximum cut-out 64mm

**Pungă colostomie**  
**Colostomy pouch**

10 1613



20 buc/cutie  
 20 pcs/box

**Pungă pentru vomă**

10 1611

• Echipat cu pad din gel cu o capacitate de absorbție a fluidelor de 450 ml.

**Vomit bag**

• Equipped with a super absorbent gel pad with the capacity of absorption of 450 ml.

**Set ginecologie-laparoscopie**

10 0130-CG5

• Componente: 1 câmp chirurgical adeziv laparoscopic 235x310cm, 1 câmp autoadeziv 75x75 cm, 1 bandă adezivă 9x50cm, 4 șervețele celuloză 20x25cm, 1 câmp steril pentru masa de operație 140x190cm.  
 • Steril

**Gynecological Laparoscopic surgery set**

• Components: 1 laparoscopic drape 235x310cm, 1 adhesive surgical drape 75 x 75 cm, 1 adhesive tape 9x50 cm, 4 cellulose napkins 20x25 cm, 1 surgical drape cover 140x190 cm, sterile, 1 piece  
 • Sterile

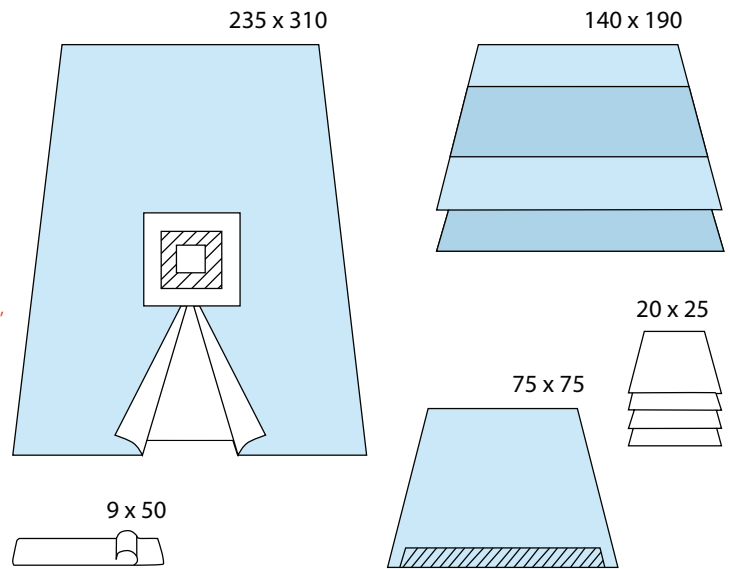

80 x 145 cm

**Câmp acoperire masă instrumente - tip Mayo**

10 1459

• 3 straturi - vâscoasă, polietilenă, strat absorbant  
 • Steril

**Instrument table cover - Mayo type**

• 3 layers - viscose, polyethylene, absorbent layer  
 • Sterile





**Halat bloc operator** 1836

- Ranforsat în zona pieptului și până la jumătatea mânecii
- Albastru
- Steril

**Disposable surgical filter suit**

- Reinforced on the chest and half of the sleeve area
- Blue
- Sterile



M	L	XL	XXL
120x150	125x155	140x165	155x170



**Halat steril** 25 0893

- Utilizat de către medici pentru asigurarea condițiilor de realizare a intervențiilor chirurgicale, fără riscuri, în cadrul cabinetelor medicale și stomatologice.
- Unitate de operare sterilă, ambalată individual, în ambalaj steril. Componentele setului sunt ambalate în hârtie specială și în pungă etansă.
- Sterile

**Sterile surgical gown**

- Used by physicians to ensure the conditions for carrying out surgery and small surgical interventions, without risk, in medical and dental offices.
- Sterile operating unit robe is individually packed in a sterile package. Kit components are packed in a special paper and in a zip-lock bag.
- Sterile

M	L	XL	XXL
120x150	125x155	140x165	155x170



**Costum filtru** 50 1825

- Albastru
- Mărimea S, M, L, XL, XXL.

**Disposable surgical filter suit**

- Blue
- Size S, M, L, XL, XXL.



**Halat examinare pacient**

- Nețesut, albastru

**Patient examination gown**

- Blue, non-woven



115 cm x 130 cm  
10 buc/pcs



6 x 11 cm      15 x 15 cm  
7.6 x 15 cm      30 x 30 cm

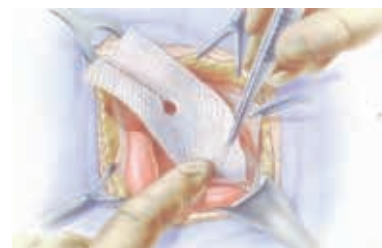

**Plasă chirurgicală**

- Cu ochiuri mici, pentru toate tipurile de henii și eventrații: dreptunghiulară, din polipropilenă
- Sterilă

**Surgical mesh**

- With small pores, for all types of hernias and eventrations rectangular, made of polypropylene
- Sterile

5 1449



resorbabil / resorbable  
10 x 10 x 10 mm  
10 buc / pcs

**Burete hemostatic**

10 1192

- Este un burete chirurgical hemostatic comprimat, fabricat la o înaltă purificare a gelatinei neutre, material excusiv de origine porcină, utilizat în diverse proceduri chirurgicale, unde hemostaza tradițională este dificilă sau impracticabilă și utilizarea altor materiale neabsorbabile este contraindicată.
- Absoarbe de aproximativ 40-50 de ori greutatea sa, nu este solubil în apă și aderă ușor la locul sângerării. Porozitatea uniformă garantează o hemostază favorabilă. Când este implantat, absorbția se face în 3-4 săptămâni.
- Sterile

**Haemostatic gelatin sponge**

- Is a compressed surgical haemostatic sponge, manufactured from highly purified neutral gelatin material exclusively from porcine origins for use in various surgical procedures. Where traditional haemostasis is difficult or impracticable and use of other non-absorbable material is undesirable.
- Absorbs approximately 40-50 times its weight, it is not soluble in water and adheres easily to the bleeding site. The uniform porosity of the sponge guarantees a favorable haemostasis. When implanted, the absorption is complete within 3-4 weeks.
- Sterile



2 gr



355-500 microni  
500 - 1000 microni  
1000 - 2000 microni

**Substitut osos**

240 1887

- Synthetic Hydroxyapatite and Beta Tricalcium Phosphate, Neobone

**Bone graft compozite**

- Synthetic Hydroxyapatite and Beta Tricalcium Phosphate, Neobone



40x30x0.2 mm

25x25x0.2 mm

15x20x0.2 mm

10 1990

**Membrana Colagen Biocollagen**

- Uz parodontal, biocompatibilă, resorbabilă
- Sterilă

**Biocollagen Collagen Periodontal Membrane**

- Biocompatible, resorbable
- Sterile

2gr  
5 plicuri / cutie  
envelopes / box

3gr  
5 plicuri / cutie  
envelopes / box



**Pudră hemostatică  
Equicel**

10 2068

- Din celuloză regenerată

**Equicel  
hemostatic powder**

- Made of regenerated cellulose



86 x 25 mm  
100 buc / pcs

**Plasture hemostatic compresiv**

2147

- Steril

**Compressive hemostatic patch**

- Sterile



1.2 ml seringă / syringe

100 2309

**Gel hemostatic**

- Pentru oprirea sângerării gingivale
- Pe bază de sulfat feric 25%

**Hemostatic gel**

- For stopping gingival bleeding
- Based on 25% ferric sulfate



2 gr

1834

**Ceara de os**

- Pentru controlul mecanic al sângerării leziunilor osoase, de culoare albă - fildeș

**Bone wax**

- For mechanic control of bleeding of bone injuries, ivory - white color

4.5x2x1.5cm  
8x2x1.5 cm  
10x2x1.5 cmv  
alb/white - albastru/blue  
1 buc/pc



100 2297

**Tampon nazal hemostatic**

- Din material PVA biocompatibil, steril

**Hemostatic nasal swab**

- Made of biocompatible PVA material, sterile



35 capse / 35 staples  
6.6 x 3,6 mm

Dispozitiv de capsat pielea, de unică folosință, cu mâner  
**Disposable skin stapler with handle**

100

1443



Dispozitiv de scos capsele, unică folosință  
**Disposable staple remover**

100

1505-UF



sterilizabil / sterilizable

Dispozitiv de scos capsele, refolosibil  
**Reusable staples remover**

100

1817-RU

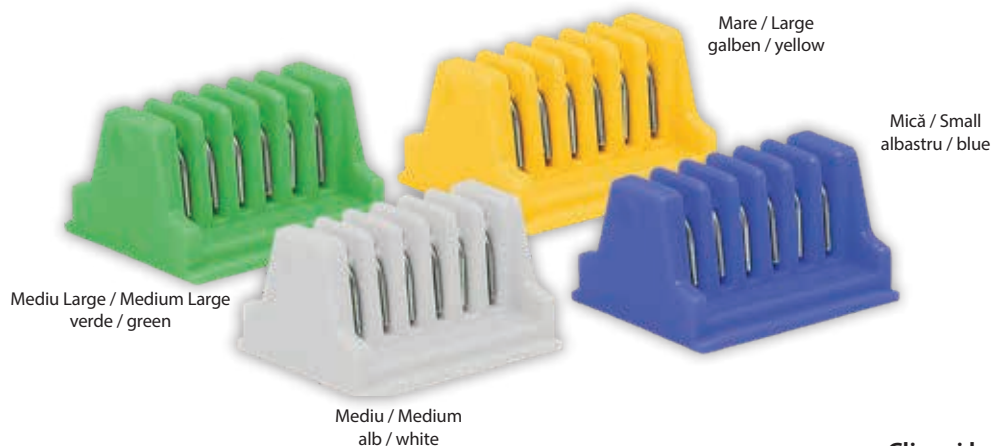

Mare / Large  
galben / yellow

Mică / Small  
albastru / blue

Mediu Large / Medium Large  
verde / green

Mediu / Medium  
alb / white

120 buc / pcs



Clipuri hemostatice, titan

• Sterile  
**Titanium hemostatic clips**  
• Sterile

20

1588

G101 Pense Plastic • Plastic Forceps

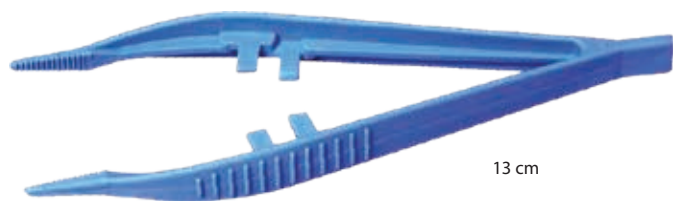

13 cm



Pensă plastic cu vârfuri ascuțite  
**Plastic splinter forceps**

500

1151

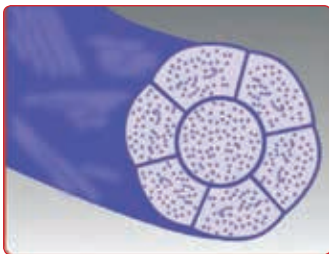

**Acid poliglicolic - resorbabilă**

• Închiderea țesutului moale superficial și a mucoasei.  
 • Indicații: chirurgie generală, chirurgie plastică, gastroenterologie și licaturi, ginecologie, ortopedie și oftalmologie, chirurgie pediatrică.

**Polyglycolic acid - resorbable**

• Closure of superficial soft tissue and mucosal tissues.  
 • Indications: General surgery, plastic surgery, gastroenterology and ligatures, gynecology, orthopedics and ophthalmology, pediatric surgery.

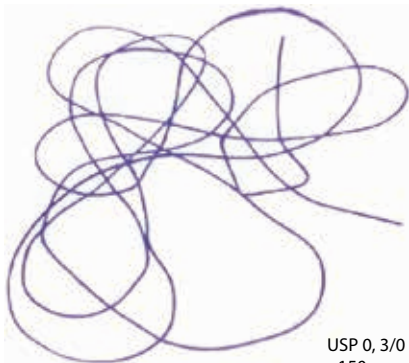

USP 0, 3/0  
150 cm



Sutură Acid Polyglycolic - Resorbabilă, fir violet, fără ac 12 1902

• Sterilă  
**Polyglycolic Acid - Resorbable, violet, without needle**  
 • Sterile

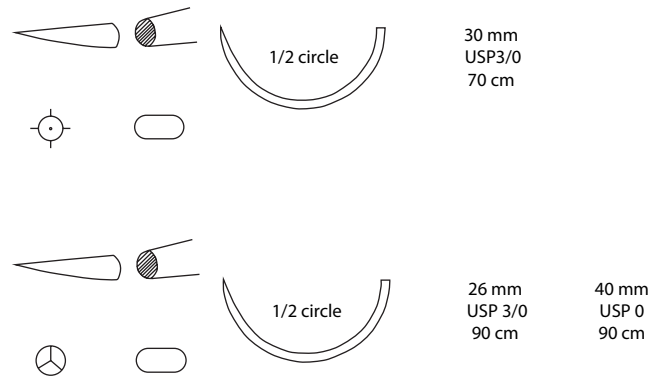
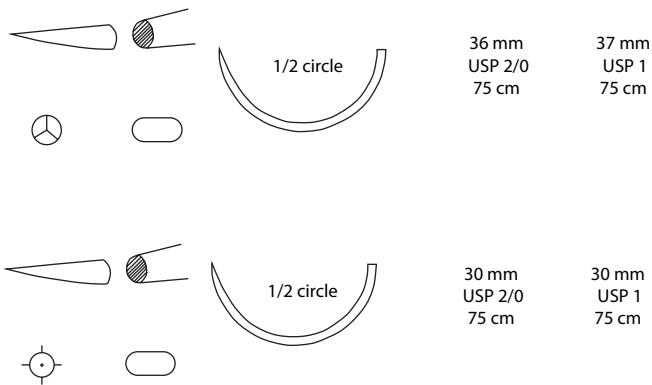

Sutură Acid Polyglycolic - Resorbabilă, fir violet 12 1900  
 • Sterilă  
**Polyglycolic Acid - Resorbable, violet**  
 • Sterile

Sutură Acid Polyglycolic - Resorbabilă, fir violet 12 1904  
 • Sterilă  
**Polyglycolic Acid - Resorbable, violet**  
 • Sterile

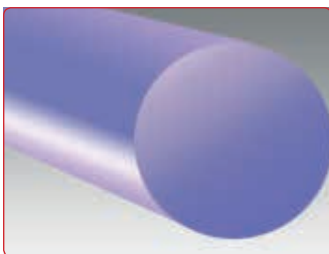

**Polidioxanona - resorbabilă**

• Închiderea țesutului moale. Trecere ușoară prin țesut fără a provoca traume acestuia.  
 Indicații: chirurgie generală, gastroenterologie, ginecologie, urologie, chirurgie plastică.

**Polydioxanone - resorbable**

• Soft tissue closure; Easy passing through tissue without causing trauma.  
 Indications: general surgery, gastroenterology, gynecology, urology, plastic surgery.

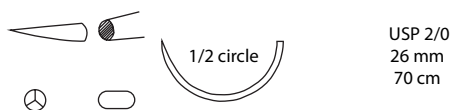

Sutură Polidioxanona - Resorbabilă, fir violet 12 1903  
 • Sterilă  
**Polydioxanone suture- Resorbable, violet**  
 • Sterile

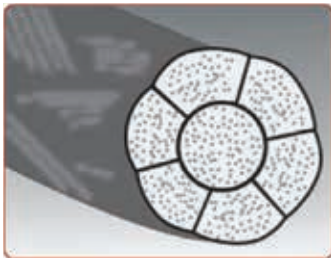

**Mătase - neabsorbabilă**

- Trecere ușoară prin țesut fără a provoca traume acestuia; asigură suport îndelungat în plagă.
- Indicații: chirurgie generală, gastroenterologie, oftalmologie, ginecologie, obstetrică.

**Silk - unabsorbed**

- Soft passage through tissues without causing trauma; provides long support in the wound.
- Indications: general surgery, gastroenterology, ophthalmology, gynecology, obstetrics.

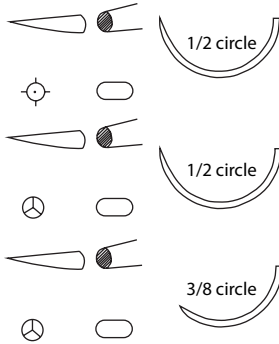

20mm, USP: 2/0  
22mm, USP: 3/0 (4/0)  
25mm, USP: 0  
75 cm

26mm, USP: 1  
30mm, USP: 2  
75 cm

USP: 0, 2/0, 3/0, 4/0  
20 - 22 mm  
75 cm



**Sutură mătase**

- Sterilă
- Silk suture**
- Sterile

50 1113

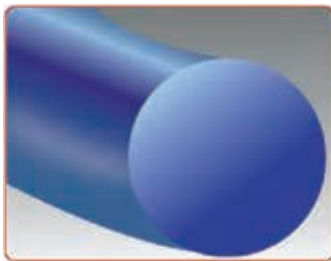

**Polipropilenă - neabsorbabilă**

- Firul asigură suport permanent în plagă; indicat pentru închiderea țesuturilor moi.
- Indicații: chirurgie cardiovasculară, chirurgie plastică, ginecologie, obstetrică, ortopedie, chirurgie generală.

**Polypropylene - unabsorbed**

- Provides ongoing support in wound thread; indicated for soft tissues closure.
- Indications: cardiovascular surgery, plastic surgery, gynecology, obstetrics, orthopedics, general surgery.

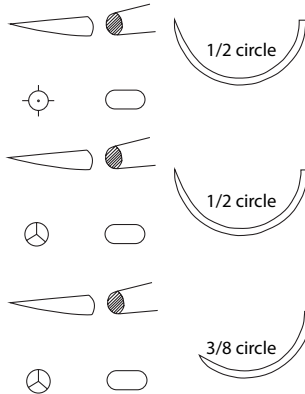

20mm, USP: 2/0, 5/0  
25mm, USP: 3/0  
30mm, USP: 0, 1, 2, 2/0, 3/0, 4/0  
40 mm, USP: 1  
75 cm

20mm, USP: 2/0  
22mm, USP: 3/0  
30mm, USP: 2/0, 3/0  
75 cm

40mm, USP: 1  
75 cm



**Sutură polipropilenă**

- Sterilă
- Polypropylene suture**
- Sterile

50 1382

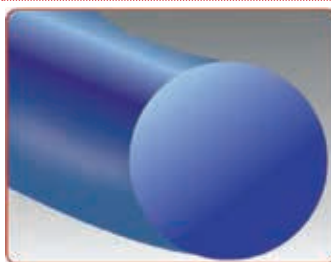

**Nylon - neabsorbabilă**

- Trecere fină prin țesut evitând ruperea acestuia.
- Indicații: chirurgie plastică și reparatorie, ortopedie, ginecologie, obstetrică, chirurgie generală.

**Nylon - non resorbable**

- Soft passage through tissues avoiding breaking the tissues.
- Indications: plastic and reconstructive surgery, orthopedics, gynecology, obstetrics, general surgery.

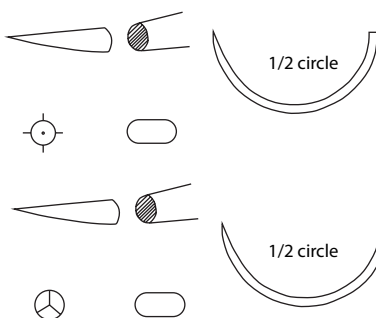

20mm, USP: 2/0, 3/0, 4/0  
75 cm

20mm, USP: 2/0, 3/0, 4/0  
75 cm



**Sutură nylon monofilament**

- Sterilă
- Nylon monofilament suture**
- Sterile

50 1383

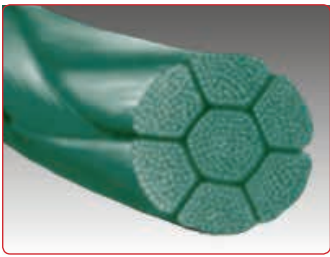

**Poliester - neresorbabil**

- Trecere ușoară prin țesut fără a provoca traume țesutului.
- Indicații: chirurgie generală, oftalmologie, ginecologie, obstetrică, gastroenterologie, chirurgie orală și închidere piele.

**Polyester - non-resorbable**

- Soft passage through tissues avoiding breaking the tissues.
- Indications: general surgery, ophthalmology, gynecology, obstetrics, gastroenterology, oral surgery and skin closure.



100 1897



100 1898

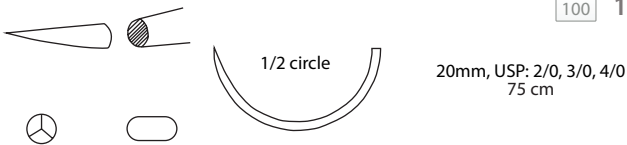

**Sutură poliester multifilament - fir verde**

- Steril
- Braided polyester suture - green thread**
- Sterile

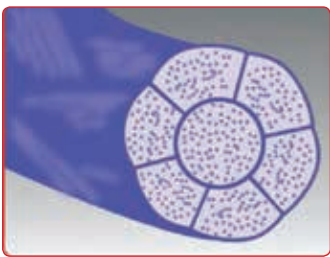

**Acid poliglicolic - resorbabilă**

- Închiderea țesutului moale superficial și a mucoasei.
- Indicații: chirurgie generală, chirurgie plastică, gastroenterologie și licaturi, ginecologie, ortopedie și oftalmologie, chirurgie pediatrică.

**Polyglycolic acid - resorbable**

- Closure of superficial soft tissue and mucosal tissues.
- Indications: General surgery, plastic surgery, gastroenterology and ligatures, gynecology, orthopedics and ophthalmology, pediatric surgery.

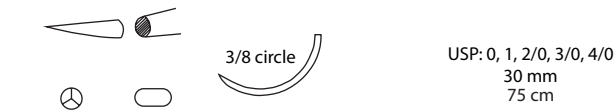

USP: 0, 1, 2/0, 3/0, 4/0  
30 mm  
75 cm

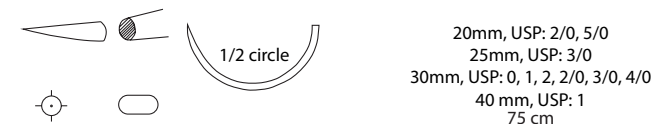

20mm, USP: 2/0, 5/0  
25mm, USP: 3/0  
30mm, USP: 0, 1, 2, 2/0, 3/0, 4/0  
40 mm, USP: 1  
75 cm

**Sutură Acid Polyglycolic - Resorbabilă, fir violet**

- Sterilă
- Polyglycolic Acid - Resorbable, violet**
- Sterile

12 1840

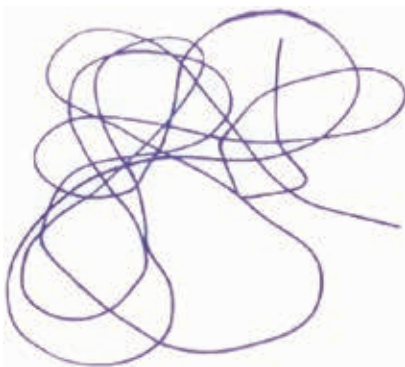

USP 0, 3/0  
150 cm



**Fir Acid Polyglycolic - Resorbabilă, fir violet, fără ac**

- Sterilă
- Polyglycolic Acid - Resorbable, violet, without needle**
- Sterile

12 1842

## G419 Foarfeci • Scissors

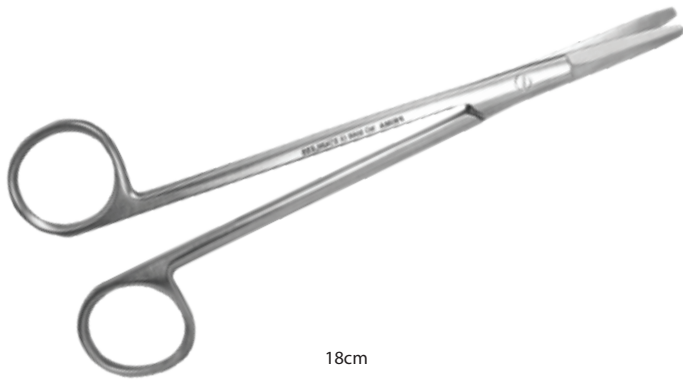

### Foarfecă Yankauer

• Dreaptă pentru tonsile, inox

#### Yankauer scissor

• Straight tonsil, stainless steel

50 2043



### Foarfecă nazală Heyman

• Oțel-inox

#### Heyman nasal scissor

• Stainless Steel

50 2042

## G298 Ace Chirurgicale • Surgical Needles

### Ace chirurgicale Surgical needles

20 1470

Tip G504, cu vârf triunghiular (reverse cutting) 1/2 Cerc, cu 1-2 ochiuri, lungimi 000-16, nesterile, din inox.

Tip B502, cu vârf triunghiular (reverse cutting), 3/8 Curb, 1-2 ochiuri, lungime 000-16, nesterile, din inox.

Tip PB538, cu vârf rotund, 1/2 Cerc, cu 1-2 ochiuri, lungimi 00-10, nesterile, din inox.

Tip GER566, cu vârf rotund, 1/2 Cerc, cu 1-2 ochiuri, lungimi 000-16, nesterile, din inox.

Tip PD534, cu vârf rotund, 3/8 Curb, cu 1-2 ochiuri, lungimi 00-10, nesterile, din inox.

G504 type, reverse cutting needle, 1/2 circle, with 1-2 eyes, length 000-16, non-sterile, stainless-steel.

B502 type, reverse cutting needle, 3/8 curved, with 1-2 eyes, length 000-16, non-sterile, stainless-steel.

PB538 type, round needle, 1/2 circle, with 1-2 eyes, length 00-10, non-sterile, stainless-steel.

GER566 type, round needle, 1/2 circle, with 1-2 eyes, length 000-16, non-sterile, stainless-steel.

PD531 type, round needle, 3/8 curved, with 1-2 eyes, length 00-10, non sterile, stainless-steel.



vârf triunghiular



vârf rotund

12 buc/pcs  
3/8 cerc - 3/8 circle

12 buc/pcs  
1/2 cerc - 1/2 circle



## G002 Ață Chirurgicală • Surgical Thread



### Ață chirurgicală din nylon

• Fir alb, lungime 75 m, fara ac, cu diametrul USP: 10 -5, nesterilă.

#### Surgical nylon thread

• White, length 75 m, without needle, diameter USP: 10 - 5, Non Sterile.

120 1475

## G047 Port Ac Suturi Chirurgicale • Surgical Needle Holders



### Port ac OLSEN-HEGAR

• Pentru suturi

#### Needle holder OLSEN-HEGAR

• For sutures

100 1776



### Foarfecă Littauer

• Pentru tăierea firelor de suturi

#### Littauer scissors

• For suture removal

100 1779

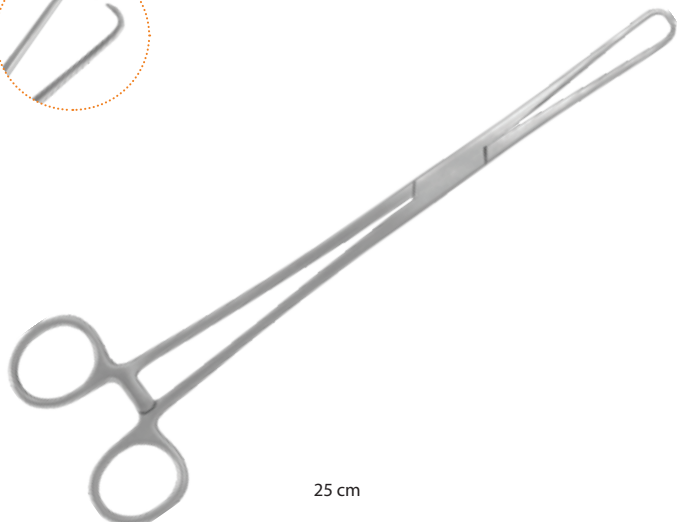
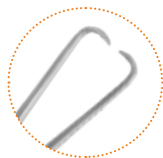

25 cm

**Pensă pentru col uterin Braun**

• Inox

**Braun cervical forceps**

• Stainless steel

50 2272

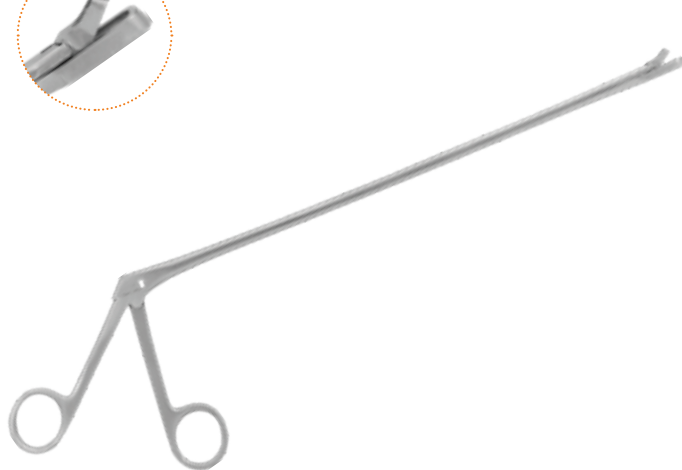

28 cm

**Pensă pentru biopsie reclată Yeoman**

• Oțel-inox

**Yeoman rectal biopsy forceps**

• Stainless Steel

50 2273



dreaptă / straight



curbă / curved

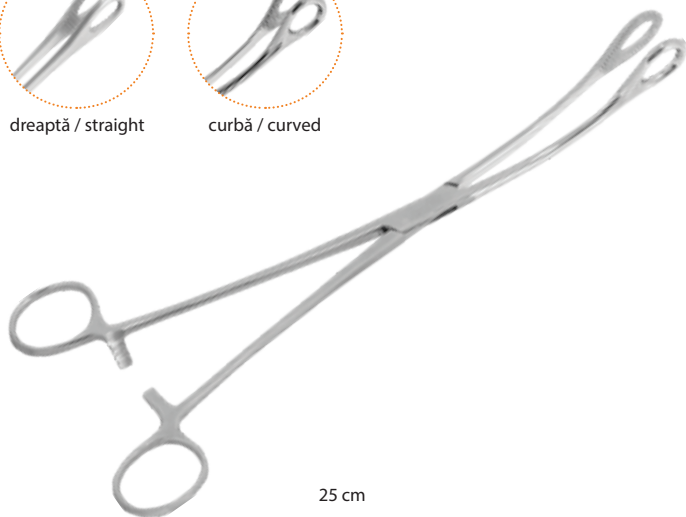

25 cm

**Pensă port-tampon Foerster**

• Inox

**Foerster port buffer forceps**

• Stainless steel

50 2274

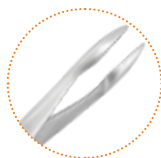

dreaptă / straight  
14 cm



curbă / curved  
16 cm

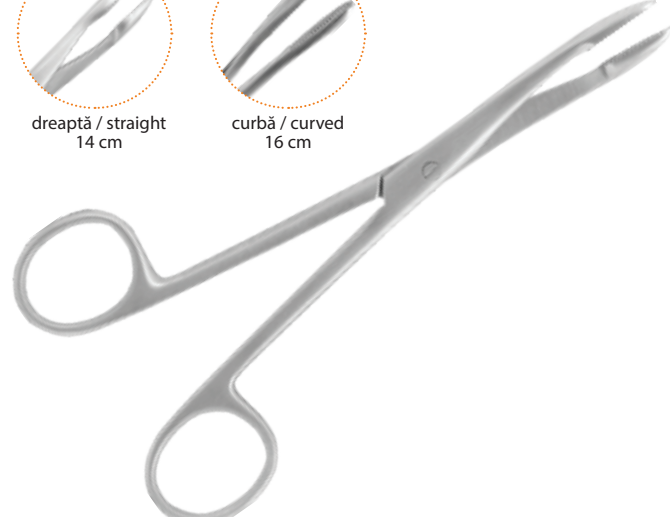

**Pensă port-tampon Gross**

• Oțel-inox

**Gross port buffer forceps**

• Stainless Steel

50 2275

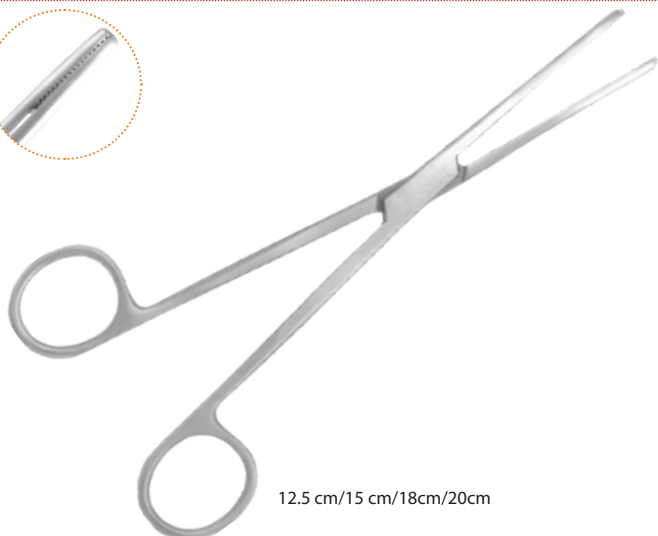

12.5 cm/15 cm/18cm/20cm

**Pensă pansamente Lister**

• Inox

**Lister dressing forceps**

• Stainless steel

50 2276



8 cm/10 cm/13 cm

**Pensă pentru câmpuri Backhaus**

• Oțel-inox

**Backhaus field forceps**

• Stainless Steel

50 2277





21 cm

**Pensă peritoneu Desjardin**

• Inox

**Desjardin peritoneum forceps**

• Stainless steel

50 2278

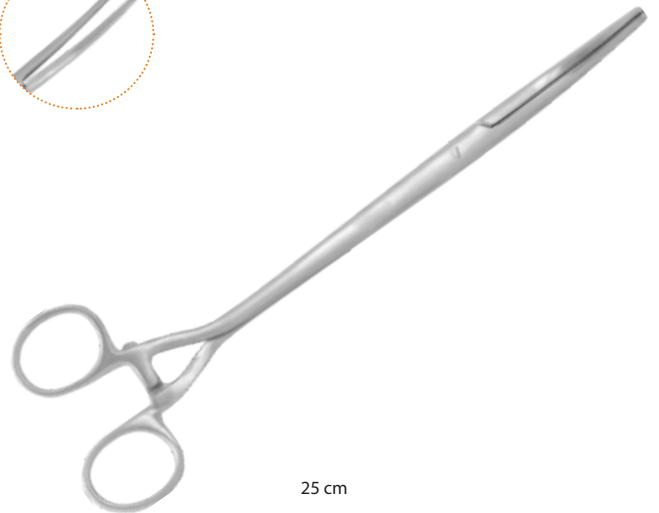
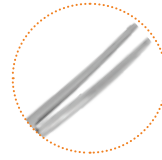

25 cm

**Pensă pentru histerectomie Faure**

• Oțel-inox

**Faure hysterectomy forceps**

• Stainless Steel

50 2279



19 cm

**Pensă pentru amigdale Colver**

• Inox

**Colver amygdala forceps**

• Stainless steel

50 2280



21.5 cm

**Pensă pentru amigdale Ballenger**

• Oțel-inox

**Ballenger amygdala forceps**

• Stainless Steel

50 2281

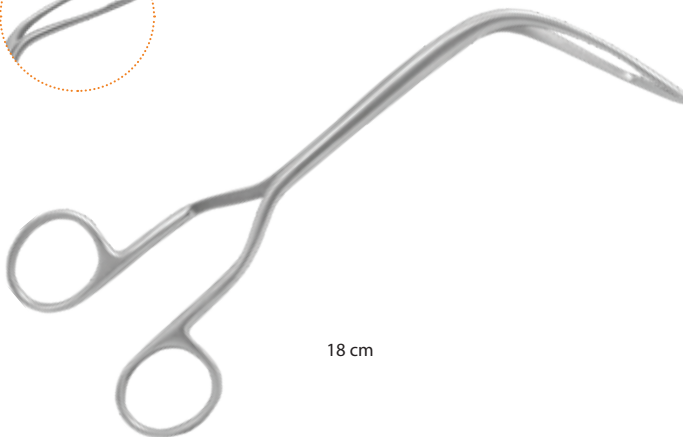

18 cm

**Pensă pentru laringe Fraenkel**

• Inox

**Fraenkel laryngeal forceps**

• Stainless steel

50 2282

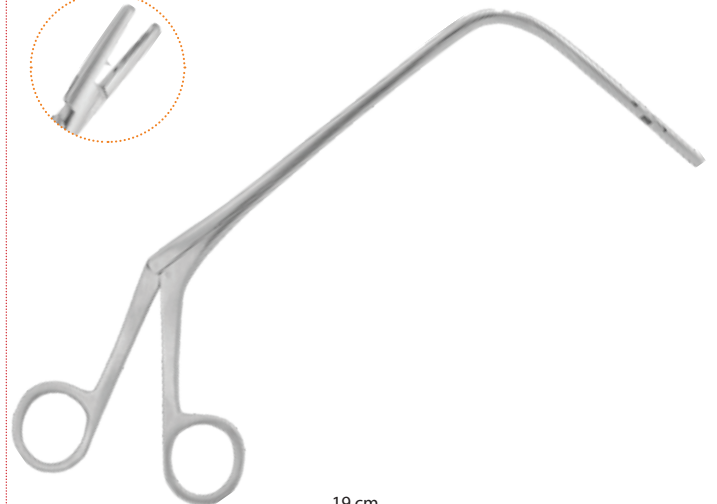

19 cm

**Pensă pentru laringe Jurasz**

• Oțel-inox

**Jurasz laryngeal forceps**

• Stainless Steel

50 2283



12 cm/13 cm

**Pensă auriculară Troeltsch**

• Inox

**Troeltsch ear forceps**

• Stainless steel

50 2284



14 cm

**Pensă auriculara Lucae**

• Oțel-inox

**Lucae ear forceps**

• Stainless Steel

50 2285



12 cm/14 cm

**Pensă auriculară Hartmann**

• Inox

**Hartmann ear forceps**

• Stainless steel

50 2286

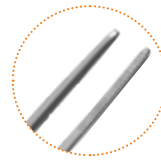

15 cm/18 cm

**Pensă nazală Troeltsch**

• Oțel-inox

**Troeltsch nasal forceps**

• Stainless Steel

50 2287

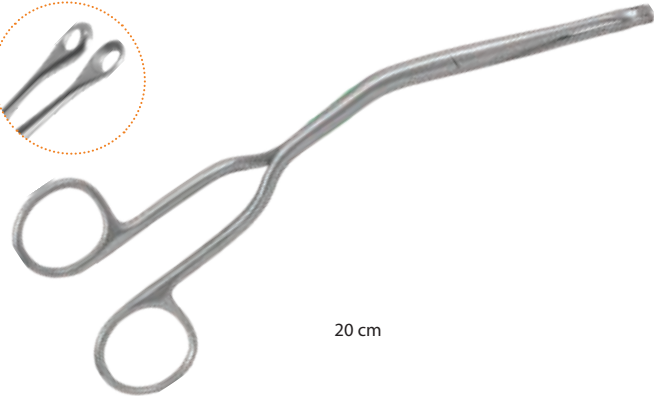

20 cm

**Pensă nazală ascuțită Luc**

• Inox

**Sharp nasal forceps Luc**

• Stainless steel

50 2288

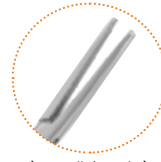

dreaptă / straight

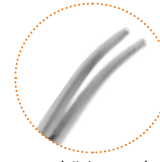

curbă / curved

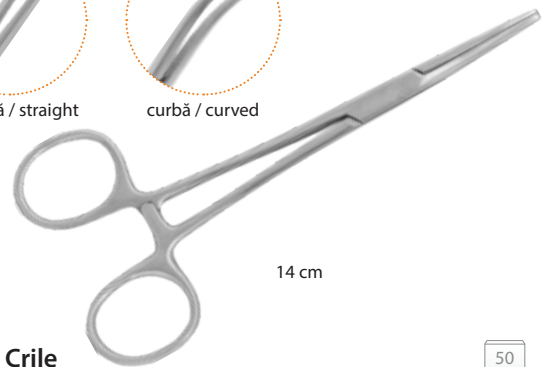

14 cm

**Pensă Crile**

• Oțel-inox

**Crile forceps**

• Stainless Steel

50 2289

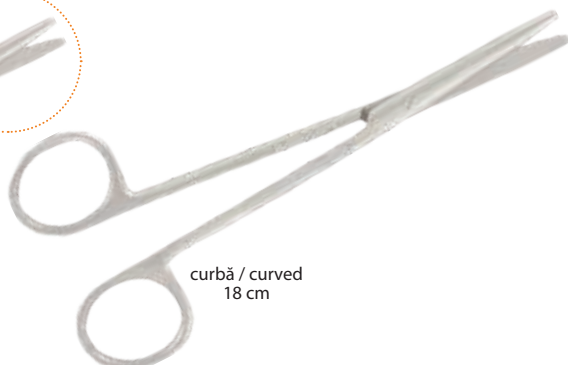

curbă / curved  
18 cm

**Foarfecă Metzenbaum**

• Inox

**Metzenbaum scissors**

• Stainless steel

50 2290

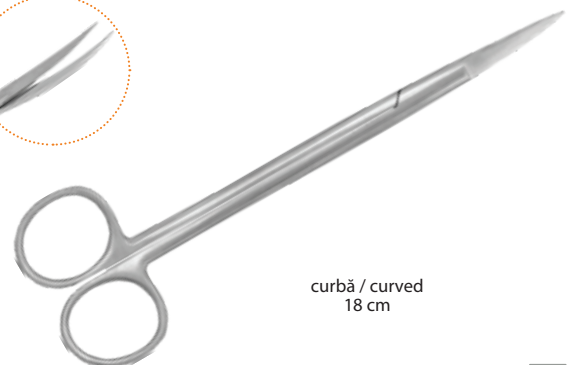
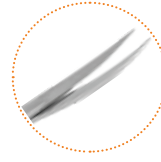

curbă / curved  
18 cm

**Foarfecă fistula Kelly**

• Oțel-inox

**Kelly fistula scissors**

• Stainless Steel

50 2291



Lame bisturiu oțel-carbon  
Surgical blades carbon-steel

50 0241

100 buc/pcs



Medical / Medical	Veterinar / Veterinary	Stomatologie/ Dentistry
<p>cardiologie, ortopedie, chirurgie plastică reparatorie</p> <ul style="list-style-type: none"> <li>utilizate pentru incizii la nivelul pielii și musculilor, în mod frecvent pentru a inciza pielea de la nivelul abdomenului</li> </ul> <p>cardiology, orthopedics, plastic repair surgery</p>	<p>chirurgia ecvinelor ( incizii ale pielii ) equine surgery ( incisions of the skin )</p>	
<p>cardiologie, ortopedie, chirurgie plastică reparatorie</p> <ul style="list-style-type: none"> <li>utilizată pentru incizii precise și pentru debridare</li> </ul> <p>cardiology, orthopedics, plastic repair surgery</p>	<p>chirurgia animalelor mici, afecțiuni ale ligamentelor încrucișate small animal surgery, cross-ligament disorders</p>	<p>chirurgia dentara</p> <ul style="list-style-type: none"> <li>utilizată în intervențiile ablație gingivale, în extracții dentare chirurgicale și în chirurgia dentoalveolară în gingivoplastie</li> </ul> <p>dental surgery</p>
<p>cardiologie, ortopedie, chirurgie plastică reparatorie</p> <ul style="list-style-type: none"> <li>unghiul ascuțit este utilizat pentru scoaterea firelor de sutură</li> </ul> <p>cardiology, orthopedics, plastic repair surgery</p>		<p>chirurgia dentara</p> <ul style="list-style-type: none"> <li>utilizată în intervențiile ablație gingivale, în extracții dentare chirurgicale și în chirurgia dentoalveolară în gingivoplastie</li> </ul> <p>dental surgery</p>
<p>cardiologie, ortopedie, chirurgie plastică reparatorie</p> <ul style="list-style-type: none"> <li>utilizate pentru incizii la nivelul pielii și musculilor, în mod frecvent pentru a inciza pielea de la nivelul abdomenului și pentru incizii mai delicatese</li> </ul> <p>cardiology, orthopedics, plastic repair surgery</p>	<p>chirurgia animalelor mici, afecțiuni ale ligamentelor încrucișate, ortopedie, endoscopie generală, chirurgia tesuturilor moi, neurochirurgie, intervenții chirurgicale în cazul displaziilor de sold, chirurgia ecvinelor ( pentru disecții fine, grefe de piele ) small animal surgery, cross-ligament disorders, orthopedics, general endoscopy, soft tissue surgery, neurosurgery, surgery for hip dysplasia, equine surgery ( for fine dissections, skin grafts )</p>	<p>chirurgia dentara</p> <ul style="list-style-type: none"> <li>utilizată în resecție apicală și în operația cu lambou pentru grefe gingivale</li> </ul> <p>dental surgery</p>
<p>cardiologie, ortopedie, chirurgie plastică reparatorie</p> <ul style="list-style-type: none"> <li>dată de unghiul care facilitează inciziile necesare în intervențiile ortotomiei. Utilizat cu predilecție în chirurgia cardiacă în artroscopie</li> </ul> <p>cardiology, orthopedics, plastic repair surgery</p>	<p>chirurgia animalelor mici, afecțiuni ale ligamentelor încrucișate, ortopedie, endoscopie generală, chirurgia tesuturilor moi, neurochirurgie, intervenții chirurgicale în cazul displaziilor de sold, chirurgia ecvinelor ( pentru disecții fine, grefe de piele ) small animal surgery, cross-ligament disorders, orthopedics, general endoscopy, soft tissue surgery, neurosurgery, surgery for hip dysplasia, equine surgery ( for fine dissections, skin grafts )</p>	<p>chirurgia dentara</p> <ul style="list-style-type: none"> <li>utilizată în resecție apicală și în operația cu lambou pentru grefe gingivale</li> </ul> <p>dental surgery</p>
<p>cardiologie, ortopedie, chirurgie plastică reparatorie</p> <ul style="list-style-type: none"> <li>utilizată pentru incizii profunde și recoltare probe ale pielii</li> </ul> <p>cardiology, orthopedics, plastic repair surgery</p>		
<p>cardiologie, ortopedie, chirurgie plastică reparatorie</p> <ul style="list-style-type: none"> <li>utilizată în chirurgia generală și ortopedică</li> </ul> <p>cardiology, orthopedics, plastic repair surgery</p>	<p>chirurgia animalelor mici, ortopedie, chirurgia tesuturilor moi, neurochirurgie, intervenții chirurgicale în cazul displaziilor de sold, afecțiuni ale ligamentelor încrucișate, chirurgia animalelor mari small animal surgery, orthopedics, soft tissue surgery, neurosurgery, surgery for hip dysplasia, cross-ligament disorders, large animal surgery</p>	
<p>cardiologie, ortopedie, chirurgie plastică reparatorie</p> <ul style="list-style-type: none"> <li>folosit pentru a tăia bronhiile în chirurgia de rezecție pulmonară</li> </ul> <p>cardiology, orthopedics, plastic repair surgery</p>		
<p>cardiologie, ortopedie, chirurgie plastică reparatorie</p> <ul style="list-style-type: none"> <li>utilizată pentru incizii ale pielii, în intervenții cardiotoracice și pentru secționarea bronhiilor</li> </ul> <p>cardiology, orthopedics, plastic repair surgery</p>	<p>chirurgia animalelor mari ( incizii ale pielii ) large animal surgery ( incisions of the skin )</p>	
<p>cardiologie, ortopedie, chirurgie plastică reparatorie</p> <ul style="list-style-type: none"> <li>utilizată pentru incizii lungi</li> </ul> <p>cardiology, orthopedics, plastic repair surgery</p>		
<p>cardiologie, ortopedie, chirurgie plastică reparatorie</p> <ul style="list-style-type: none"> <li>utilizată pentru incizii în unghi, debridări și pentru tăierea bandajelor</li> </ul> <p>cardiology, orthopedics, plastic repair surgery</p>	<p>chirurgia ecvinelor ( incizii ale pielii ) equine surgery ( incisions of the skin )</p>	
<p>cardiologie, ortopedie, chirurgie plastică reparatorie</p> <p>cardiology, orthopedics, plastic repair surgery</p>		



#3 lame / blades, 10 - 17  
#4 lame / blades, 18 - 24

1 buc / pc 400  
10 buc / pcs 40

### Mâner bisturii, inox

- Oferă rezistență sporită și controlul precis al vârfului degetului
- Design ergonomic

### Stainless steel handles

- Provides high resistance and precise fingertip control
- Ergonomic design



diametru / diameter: 1/2/2.5/3/3.5/4/5/6/7/8mm

### 0658 Pensă Punch pentru biopsie

- Sterilă, oțel inoxidabil
- Pentru obținerea specimenului de piele din profunzime în vederea diagnosticării

### Punch forceps for biopsy

- Sterile, stainless steel
- For obtaining diagnostic full-thickness skin specimen

10 2141

### Bisturiu de unică folosință cu mâner din plastic 50 1302

- Bisturiu monobloc. Se folosește pentru chirurgie, disecția anatomică. Ușor de utilizat. Mâner din plastic care oferă dexteritate și distanță față de rană. Acesta permite eliminarea în siguranță după folosire. Oferă o prindere sigură.
- De unică folosință: nu se poate autoclava.
- Ambalat individual și închis ermetic în folie de aluminiu.
- Steril

### Disposable surgical scalpel with plastic handle

- Sed for surgery, anatomical dissection. Easy to use. Plastic handle allowing dexterity and distance from the wound. It allows safe disposal after use. Provides a secure grip.
- Single-use and non-autoclavable.
- Blades come individually wrapped and hermetically sealed in aluminum foil
- Sterile



mărimi / sizes 10, 11, 15

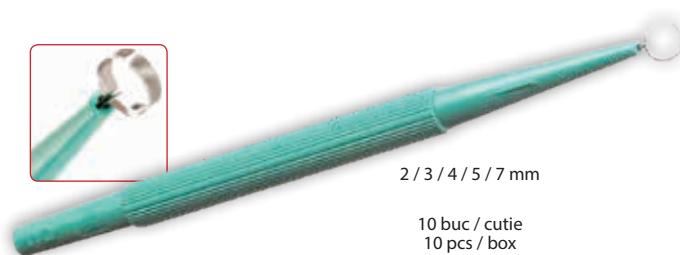

2 / 3 / 4 / 5 / 7 mm

10 buc / cutie  
10 pcs / box

### Chiurete dermatologice sterile, inox 50 1687

- Steril

### Sterile stainless steel dermatological curettes

- Sterile



14 cm

### Marker pentru piele 200 1550

- Cu vârf normal și riglă

### Skin marker for surgery

- Regular tip and ruler



### Pensa bipolară ADSON 10 1952

- Pentru electrochirurgie, lungime pensă 18 cm
- Vârfuri drepte cu lungimea de 1 mm, conector US

### ADSON bipolar forceps

- Length 18 cm, straight tips with length of 1mm, US connector



### Cablu bipolar 5 1953

- Pentru accesorii electrochirurgie, din silicon

### Bipolar cord

- For electro-surgery, made of silicone

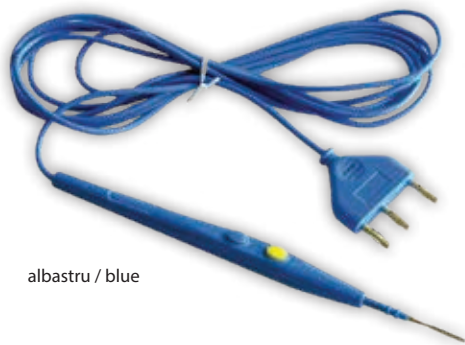

albastru / blue

**Creion electrochirurgical**

• Tăiere și cauterizare, 70 mm, 2 butoane, cablu 3 m, ștecher 3 pini.

**Electrosurgical pencil**

• Cutting & cauterizing, 70 mm, 2 switches, cable 3 m, 3-prong connector.

100

0604



150 x 90 mm  
copii / children

210 x 100 mm  
adulti / adults

1 buc. pe pungă de aluminiu  
1 pc. per aluminium foil patch

**Electrod neutru pentru electrocauter**

• Tip plăcuță cu gel solid.

**Grounding plate for electrocautery pencil**

• With solid gel.

400

1346



13 cm

**Electrocauter Unica Folosință**

• 600°C, Varf Fin 15 x 130 mm, (Oftalmologie)  
• Steril

**Disposable Electrocautery Pencil**

• 600°C, Fine Tip, 15 x 130 mm, (Ophtalmology)  
• Sterile

10

1548-F7255



18 cm

**Electrocauter Unica Folosință**

• 800°C, Varf Gros 15 x 180 mm, (Hematoame Ungghii, Cosmetică)  
• Steril

**Disposable Electrocautery Pencil**

• 800°C, Thick Tip, 15 x 180 mmm, (Haematoma, Perforation of Nails, Cosmetics)  
• Sterile

10

0730-F7288



18 cm

**Electrocauter unică folosință**

• Ginecologie, cardiologie, chirurgie toracică și cardiovasculară, neurochirurgie, ortopedie, otolaringologie, urologie, chirurgie plastică și reconstructivă, etc.  
• Temperatura de lucru maximă 1.200 °C ( 2.200 °F ), vârf mare.

• Steril

**Disposable electrocautery**

• Surgical procedures in : gynecology, cardiology, cardiovascular surgery, orthopedics, urology, plastic and reconstructive surgery.

• Maximum working temperature 1.200 °C ( 2.200 °F ), large tip.

• Sterile

10

0604-F7266



18 cm

**Electrocauter unică folosință**

• Ginecologie, cardiologie, chirurgie toracică și cardiovasculară, neurochirurgie, ortopedie, otolaringologie, urologie, chirurgie plastică și reconstructivă, etc.  
• Temperatura de lucru maximă 1.200 °C ( 2.200 °F ), vârf fin.

• Steril

**Disposable electrocautery**

• Surgical procedures in : gynecology, cardiology, cardiovascular surgery, orthopedics, urology, plastic and reconstructive surgery.

• Maximum working temperature 1.200 °C ( 2.200 °F ), fine tip.

• Sterile

10

0604-F7244



21 cm

**Electrocauter unică folosință**

• Ginecologie, cardiologie, chirurgie toracică și cardiovasculară, neurochirurgie, ortopedie, otolaringologie, urologie, chirurgie plastică și reconstructivă, etc.

• Temperatura de lucru maximă 1.200 °C ( 2.200 °F ), vârf fin lungime 75 mm ( 3" ), lungime totală 210 mm ( 8.25" ). • Steril

**Disposable electrocautery**

• Surgical procedures in : gynecology, cardiology, cardiovascular surgery, orthopedics, urology, plastic and reconstructive surgery.

• Maximum working temperature 1.200 °C ( 2.200 °F ), fine tip lenght 75 mm ( 3" ), total lenght 210mm ( 8.25" ). • Sterile

10

0604-F7234



29 cm

**Electrocauter unică folosință**

• Ginecologie, cardiologie, chirurgie toracică și cardiovasculară, neurochirurgie, ortopedie, otolaringologie, urologie, chirurgie plastică și reconstructivă, etc.

• Temperatura de lucru maximă 1.200 °C ( 2.200 °F ), vârf fin lungime 125 mm ( 5" ), lungime totală 290 mm ( 11.5" ). • Steril

**Disposable electrocautery**

• Surgical procedures in : gynecology, cardiology, cardiovascular surgery, orthopedics, urology, plastic and reconstructive surgery.

• Maximum working temperature 1.200 °C ( 2.200 °F ), fine tip lenght 125 mm ( 5" ), total lenght 290mm ( 11.5" ). • Sterile

10

0604-F7277



**Seringi insulină, ac detașabil, piston cauciuc**  
**Disposable insulin syringe set, detachable needle, rubber piston**

1 ml ac / needle 29 G 1/2'  
 (0,33 x 13 mm)  
 100 buc / cutie - 100 pcs / box

20 1488-01



1 ml ac/needle 29G 1/2'  
 (0.33 x 13 mm)  
 100 buc/cutie - 100 pcs/box

20 0872-01



0.5 ml ac/needle 30G 1/2'  
 (0.33x13mm)  
 100 buc/cutie - 100 pcs/box

20 0872-005

**Seringi insulină, ac nedetașabil, piston cauciuc**  
**Disposable insulin syringe set, undetachable needle, rubber piston**



2/2.5 ml - 100 buc / pcs  
 5 ml - 100 buc / pcs  
 10 ml - 100 buc / pcs  
 20 ml - 50 buc / pcs

30  
 24  
 16  
 16



**Seringi fără ac, Luer Slip, din 2 părți ( corp, piston )** 1468  
**Disposable syringe set without needle, Leur Slip, 2-parts ( body, plunger )**



2ml, 23G 1' (0.6 x 25 mm - albastru/blue) - 100 buc  
 5ml, 21G 1½" (0.8 x 38 mm - verde/green) - 100 buc  
 10 ml, 21G 1½" (0.8 x 38 mm - verde/green) - 100 buc  
 20 ml, 18G 1½' (1.2 x 38 mm - roz/pink) - 50 buc  
 50/60 ml ac 18G 1½' (1.2 x 25 mm - roz/pink) - 25 buc

30  
 24  
 16  
 16  
 16

**Seringi cu ac, Luer Slip, piston cauciuc**  
**Disposable syringe set with needle, Leur Slip, rubber piston**

0236



- 2ml, 23G 1' (0.6 x 25 mm - albastru/blue) - 100 buc
- 5ml, 22G 1¼' (0.7 x 32 mm - negru/black) - 100 buc
- 10 ml, 21G 1½' (0.8 x 38 mm - verde/green) - 100 buc
- 20 ml, 18G 1½' (1.2 x 38 mm - roz/pink) - 50 buc
- 60 ml, 18G 1½' (1.2 x 38 mm - roz/pink) - 25 buc

- 30
- 24
- 16
- 16
- 16

**Seringi cu ac, Luer Lock, piston cauciuc** 0574  
**Disposable syringe set with needle, Luer Slip, rubber piston**

G366 Seringi Guyon • Guyon Syringes



100 buc/pcs

**Dopuri de cauciuc**  
 • Pentru obturarea seringilor  
**Rubber stopper**  
 • Syringe caps

10 1617



60 ml - 25 buc / pcs

100 ml - 25 buc / pcs

**Seringi tip Guyon** 16 1538

• Din 3 părți ( piston plastic, corp, garnitură ). Folosite pentru alimentație, aspirație sau irigație.

**Guyon Syringes**

• With three parts ( body, plastic piston, piston seal ). Used for feeding, suction or irrigation.

G069 Ace Seringă • Syringe Needles



100 buc/pcs



**Ace seringă**  
**Disposable needles**

100 0233

- ✓ 18G, 1 1/2' (1,20 x 38 mm - roz / pink)
- ✓ 19G, 1 1/2' (1,10 x 38 mm - galben deschis / light yellow)
- ✓ 20G, 1 1/2' (0,90 x 38 mm - galben / yellow)
- ✓ 21G, 1 1/2' (0,80 x 38 mm - verde / green)
- ✓ 22G, 1 1/2' (0,70 x 38 mm - negru / black)
- ✓ 23G, 1 1/4' (0,60 x 32 mm - albastru / blue)
- ✓ 24G, 1' (0,55 x 25 mm - mov / purple)
- ✓ 25G, 3/4' (0,50 x 19 mm - portocaliu / orange)
- ✓ 26G, 5/8' (0,45 x 16 mm - maro / brown)
- ✓ 30G, 1/2" (0,30 x 13 mm - galben pal / pale yellow)

- ✓ 18G, 19G, 20G, 21G, 22G, 23G, 24G, 25G, 26G
- Pentru puncții și anestezii în coloana vertebrală
- For anesthesia



50 buc / pcs

**Ace Spinale**  
• Sterile  
**Huber Needle**  
• Sterile

20 1416

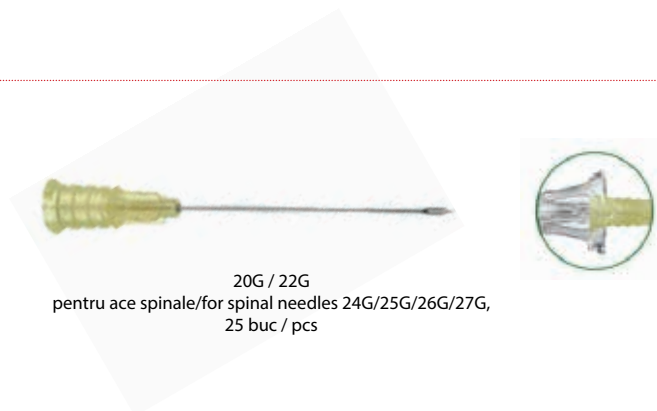
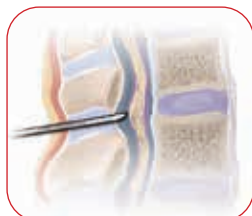

20G / 22G  
pentru ace spinale/for spinal needles 24G/25G/26G/27G,  
25 buc / pcs

**Ace metalice introductoare**  
• Sterile  
**Metallic introducer**  
• Sterile

200 1828

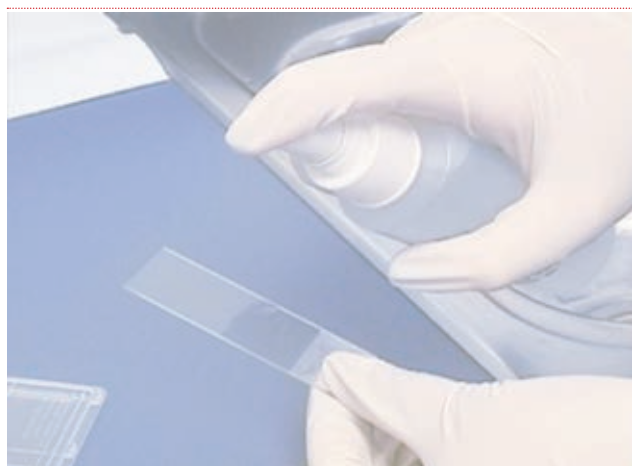

**Spray pentru fixarea probelor citologice**  
• Pe bază de alcool pentru păstrarea și transportul probelor  
**Citology fixative spray**  
• Alcohol based spray type fixative for the preservation and transport of samples

24 1788



240 ml



2 buc/pcs

**Accesoriu distrugător de ace seringi**  
**Syringe needle destroyer accessory**

1889



22x14x9 cm

**Distrugător de ace seringi**  
• Temperatura de fuziune 1000°C  
**Syringe needle destroyer**  
• Fusion temperature 1000°C

1888





25 buc / 25 pcs  
ac / needle 21Gx 1½"

16

16

### Trusa perfuzie

0789

- Acul de plastic este prevăzut cu filtru special antibacterian care permite intrarea aerului, dar nu permite contaminarea lichidelor.
- Ace din oțel-inox, 21Gx 1/2", siliconate, netoxice. Camera de aer cu picurator și filtru care nu permite trecerea impurităților. Dispozitiv de reglare a debitului soluției perfuzabile. Materiale: PVC pentru uz medical, de înaltă calitate.
- Sterilă

### Infusion set

- The plastic needle is designed with special anti-bacterial filter that allows air to enter but prevents liquid contamination.
- Stainless steel needles, 21Gx1 1/2", siliconized, non-toxic. Flow regulator. Air filter and drain room which doesn't allow impurities. Material: high quality medical grade PVC.

### G352 Truse Transfuzie sânge • Blood Transfusion Kits



25 buc / pcs  
ac 18G x 1 1/2" și spike plastic  
needles 18G x 1 1/2" and plastic spike

### Trusă transfuzie cu ac și spike plastic

- Sterilă

### Blood Transfusion set with needle and plastic spike

- Sterile

20 1440

### Pungă de recoltare sânge simplă cu ac 16 G

10 1657

- Cu anti coagulant (citrat fosfat dextroză adenină CPDA-1)

### Single blood collection bag with 16G needle

- Contains CPDA-1 anticoagulant solution



450 ml  
5 buc / pcs

### Tub extensie/prelungitor pentru perfuzie/injectomat/seringă automată

10 1466

- Tubul de extensie este conceput pentru a conecta sursa perfuziei ( exemplu, trusa de perfuzie sau seringă 50 ml din infuzomat ) cu zona de perfuzat ( de exemplu, branula, pentru a extinde distanța dintre acestea.
- Rezistent la presiunea ridicată a perfuziei, ambalat individual.
- Steril

### Extension tube/infusion extension tube/Syringe Pump

- The extension tube is designed to connect the infusion source ( for example the infusion kit or the 50 ml syringe of the infusomat ) with the infusion area ( for example the catheter ) to expand the distance between them.
- Resistant to high pressure infusion, individually packed.
- Sterile



50 buc / pcs  
lungime / length 150 cm,  
diametru / diameter 2.3 mm,  
de unică folosință / disposable

### G073 Robineți Perfuzie 3 Căi • 3 Way Stop Cock



50 buc/pcs

### Robineți perfuzie cu trei căi simpli Simple three way stopcock

10 0767-SIM



40 buc/pcs

100 cm

### Robineți perfuzie cu trei căi de extensie Three way stopcock extension

10 0767-EXT



**Microperfuzoare**

20 0806

- Pentru mărimi mici - tratarea în pediatrie, secția noi-născuți ( +prematuri). Pentru mărimi mai mari - tratarea adulților. Timp de utilizare recomandat: 24 ore.
- Canulă din oțel inoxidabil. Aripioare flexibile ( fluturași ).
- Sterile

**Scalp Veins Sets ( intravenous cannula, two fins, tube with Luer-Lock)**

- For small sizes: for treatment of pediatric, new born and premature section. For large sizes: for adult treatment. Recommended usage time: 24 hours.
- Stainless steel cannula. Flexible wings ( fliers ).

100 buc/pcs - steril/sterile	22G ( 0.7 x 19 ) negru - black
19G ( 1.1 x 19 ) crem - cream	23G ( 0.6 x 19 ) albastru - blue
20G ( 0.9 x 19 ) galben - yellow	25G ( 0.5 x 19 ) orange - orange
21G ( 0.8 x 19 ) verde - green	27G ( 0.4 x 19 ) gri - grey



100 buc/pcs

**Adaptor Luer Lock de recoltare sânge pentru vacutainer**

10 1340

- Test pentru detectarea agentului patogen de filarioză canină în sânge, ser și plasmă
- Steril

**Holder with Luer Lock adaptor for blood collection tube**

- For detection of adult worm in canine serum, plasma or whole blood, antigen
- Sterile

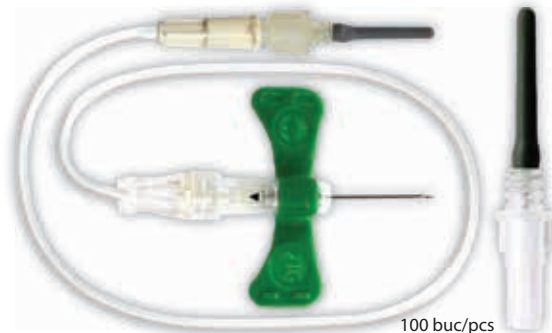

100 buc/pcs

**Adaptor microperfuzor - vacutainer**

20 1281

- Adaptor pentru reocplare probe, cu microperfuzor, folosit în cadrul tuturor secțiilor din spitale, clinici, incluzând secții de terapie intensivă și servicii de ambulanță.
- De unică folosință. Nu este toxic, nepirogenic. ✓Steril

**Adaptor for scalp veins, blood collection tube**

- Adaptor used for taking medical samples in all hospital departments, clinics, including intensive care units and ambulance services.
- Disposable. Non-toxic and non-pyrogenic. ✓Sterile



**Ac Huber**

30 1566

- Steril

**Huber Needle**

- Sterile

- ✓ 20G x 15 mm
- ✓ 20G x 20 mm
- ✓ 20G x 25 mm
- ✓ 22G x 15 mm
- ✓ 22G x 20 mm
- ✓ 22G x 25 mm

cu aripioare / with wings  
pentru administrarea substanțelor de chimioterapie  
for administration of chemo treatments



100 buc/pcs

- ✓ 14G ( 2.10 x 45 ) portocaliu- orange
- ✓ 16G ( 1.70 x 45 ) gri - grey
- ✓ 18G ( 1.30 x 45 ) verze - green
- ✓ 20G ( 1.10 x 32 ) roz - pink
- ✓ 22G ( 0.90 x 25 ) albastru - blue
- ✓ 24G ( 0.70 x 19 ) galben - yellow
- ✓ 26G ( 0.60 x 19 ) violet - purple

**Branule cu valvă și cateter F.E.P.**

10 1179

- Administrarea intravenoasă intermitentă de medicamente.
- Pentru menținerea hidratații și/sau corectarea deshidratării, dacă pacientul nu este capabil să ia pe cale orală un volum suficient de fluide, Luer Lock
- Sterile

**I.V. Cannula with F.E.P. radiopaque catheter & injection valve**

- Intermittent intravenous drugs administration.
- To maintain hydration and/or correct dehydration if patient is unable to take sufficient volume of oral fluid, Luer Lock



250 buc/pcs

**Dopuri pentru branule**

20 2000

- Pentru prevenirea scurgerilor soluțiilor medicamentoase, transparente din PVC și latex
- Sterile

**Injection stopper**

- Contains CPDA-1 anticoagulant solution



10 cm x 4 m  
10 cm x 5 m

24 role/rolls

- 10 cm x 10 m 600
- 15 cm x 10 m 288
- 20 cm x 10 m 150



**Fașă tifon în banderolă hârtie**  
**Cotton gauze bandages in paper muff**

25 1083

**Fașă tifon ambalată individual**  
**Cotton gauze bandages**

0251



100% bumbac/cotton  
90 cm x 100 m

**Rolă tifon ambalată individual - margini pliate** 30 0937  
**Cotton gauze roll - folded edges**



6 cm x 3 m, parte abs. / abs. part 6 x 8 cm  
8 cm x 4 m, parte abs. / abs. part 8 x 10 cm  
10 cm x 4 m, parte abs. / abs. part 10 x 12 cm

pentru acoperirea și tratamentul rănilor  
to cover and treat wounds

**Fașă tifon cu parte absorbantă**  
**Cotton gauze bandage with absorbent area**

100 1511

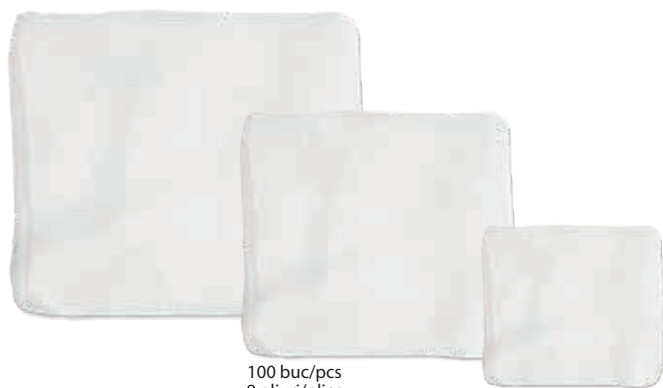

100 buc/pcs  
8 pliuri/plies

**Comprese tifon**  
• Sterile  
**Cotton Gauze Swabs**  
• Sterile

0259

- 10 x 10 cm 100
- 7.5 x 7.5 cm 200
- 5 x 5 cm 300



**Comprese tifon tăiate**  
• Sterile  
**Cotton Gauze Swabs, cuted edges**  
• Sterile

0510

- 10 buc / pcs 1200
- 25 buc / pcs 600
- 50 buc / pcs 300





1200 1082-12  
10 x 10 cm  
12 straturi/ply  
1 compresă pliată/1 pcs  
per pouch

360 1082-48  
10 x 10 cm  
48 straturi/ply  
4 compresă pliată/4 pcs  
per pouch

**Comprese tifon**

- Sterile
- Cotton Gauze Swabs, with EO**
- Sterile

**Comprese cu fir radio opac detectabil cu raze X**

16 1562

• Comprese cu margini pliate în 12 straturi și fir detectabil întrețesut cu raze X. Cu margini tăiate. Produs steril, de unică folosință. Procentul de sulfat de bariu din firul radioopac este de 60%. Fir rezistent, flexibil și ușor detectabil.

**Cotton gauze swabs with X-rays detectable thread**

- Gauze swabs folded in 12 plies and interwoven X-ray detectable thread. With cut edges. Sterile product, for single use. X-ray detectable thread. Contains 60% barium sulfate. Resistant thread, flexible and easy to detect.



5 x 5 cm pliată/folded  
15 x 15 cm nepliată / unfolded  
12 straturi / ply  
1 bucată pliată per plic /  
1 folded pc per pouch

**Compresă tifon**

- Sterile
- Cotton Gauze Swabs, with EO**
- Sterile

20 1890-100

**G048 Comprese Nețesut • Nonwoven Gauzes**



40 x 60 cm  
DIN 13152-BR  
1 buc/plic 1 pc/envelope

60 x 80 cm  
DIN 13152-A  
1 buc/plic 1 pc/envelope

**Compresă PPSB**

- Pentru acoperirea rănilor de dimensiuni mari
- Sterilă

**PPSB Gauze**

- Used for covering large wounds
- Sterile

10 1512

**Compresă TNT**

- Sterilă
- PPSB Gauze**
- Sterile

40 x 60 cm  
40 straturi / ply

200 1720



**Compresă PPSB sterilă**

- Ideal pentru aplicarea antisepticilor sau a unguentelor, pentru curățarea și acoperirea ranilor
- Sterilă

**PPSB gauze swabs sterile**

- Ideal for applying antiseptics and ointments, for cleaning and covering minor wounds
- Sterile



10 cm x 10 cm  
2 buc/pcs

**G079 Comprese Nețesut cu Alcool • Nonwoven Pads with Alcohol**



100 buc / pcs 100 1081-100

200 buc / pcs 50 1081-200

**Tampoane PPSB**

- Impregnate cu alcool izopropilic 70%

**Prep PPSB pads**

- With alcohol 70%

**G080 Tampoane din Celuloză • Cellulose Pads**



5x4 cm  
3 straturi / layers  
1000 buc/rolă - pcs/roll

10 0968-COS

5x4 cm, 2 straturi / layers  
uz medical / medical use  
nesterile / non-sterile  
1000 buc/rolă - pcs/roll

12 0968-MED

**Tampoane de celuloză albă fără clor**

- Cellulose Pads, chlorine-free bleached**



Nr.0 si Nr.1 pentru degete  
No.0 and Nr.1 for fingers

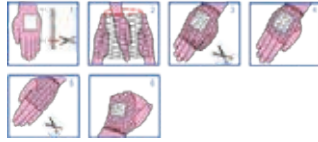

Nr.2 pentru mana si incheietura mainii  
No.2 for hand and wrist



Nr.3 pentru mana, cot si brat  
No.3 for hand, elbow and arm

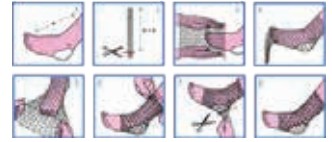

Nr.4 pentru brat, cot si picior  
No.4 pentru arm, elbow and foot

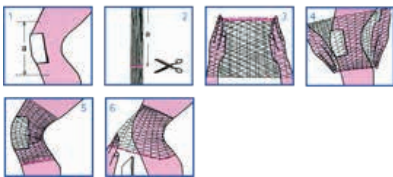

Nr.5 pentru picior, genunchi si gamba  
No.5 pentru foot, knee si ankle

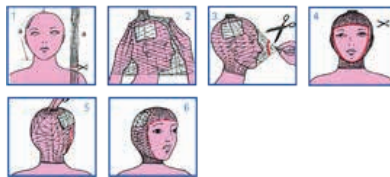

Nr.6 pentru cap, picior, umar si bazin  
No.6 for head, foot, elbow and pelvis

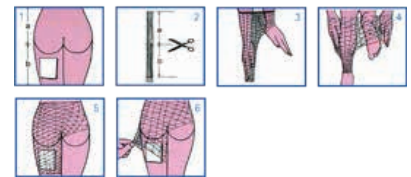

Nr.7 pentru corp, bazin si coapsa  
No.7 pentru body, pelvis and hip

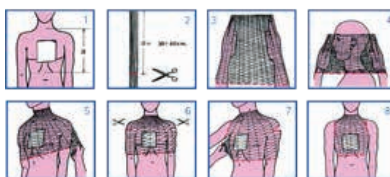
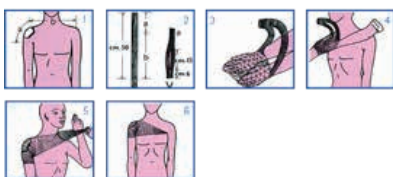

Nr.8 , Nr.9 si Nr. 10 pentru umar, corp si spate  
No.8 , No.9 si No. 10 for shoulder, body and back

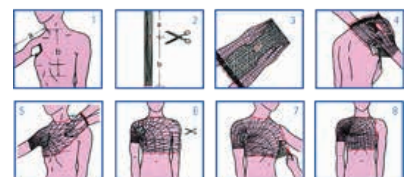



3.5g  
6 buc/pcs

**Gel calmant pentru arsuri, plic**  
**Burn gel, envelope**

90 1450-6P3.5



118 ml

**Gel calmant pentru arsuri, flacon**  
**Burn gel, bottle**

72 1450-F118



5 x 5 cm  
10 buc / pcs  
10 x 10 cm  
10 buc / pcs  
10 x 20 cm  
5 buc / pcs

500

500

500

**Pansament cu alginat de calciu**

• Pentru vindecarea plagilor cu exudat

**Calcium alginate dressing**

• For wound healing with exudate

2127



120 ml

160



50 ml

48

**Gel calmant pentru arsuri, spray**  
**Burn gel, spray**

1450-S050/S120



10 x 10 cm

48

20 x 20 cm

120

**Compresă impregnată cu gel calmant**  
**Burn dressing**

1451



75 x 100 mm  
10 buc/pcs

**Compresă impregnată cu substanță grasă (anhidră)**  
**Paraffin gauze dressing**

10 1457



5 x 5 cm  
2 bucați per plic, 32 plicuri  
2 pcs/envelope, 32 envelopes

**Comprese sterile** [32] 0891

• Pliate în 8

**PPSB gauzes**

• Folded in 8



5 x 5 cm  
100 bucați / pcs

**Comprese sterile** [300] 0891

• Pliate în 4

**PPSB gauzes**

• Folded in 4



**Comprese nesterile PPSB** [300] 0891

• Pliate în 4

**PPSB gauzes**

• Folded in 4



56 x 70 mm  
25 buc / pcs

**Comprese oculare** [48] 1456-54X70

• Comprese din bumbac, înveliș din tifon și corp absorbant pentru tratarea rănilor  
• Sterile

**Eye pads**

• Made of cotton wool with gauze covering and absorbent body for the treatment of the wounds  
• Sterile



250 ml

**Soluție NaCl 0.9%** [20] 0928

• Soluție pentru irigarea ochilor și a plăgilor, cu duza de pulverizare, flacon 250 ml  
• Sterilă

**Irrigation solution NaCl 0.9%**

• For eyes and wounds, with spray nozzle, bottle 250 ml  
• Sterile



20 cm x 10 cm  
100 buc/pcs

**Comprese nesterile PPSB** [20] 0807

• Pliate în 4

**PPSB non sterile gauzes**

• Folded in 4



5 tamponae/plic - 50 plicuri/cutie  
5 tampons/sachet - 50 sachets/box

**Tampoane chirurgicale oftalmologice** [25] 2099

• Triunghiulare, din material PVA, înalt absorbant  
• Sterilă

**Ophthalmic surgical swabs**

• Triangular, made of high absorbant PVA  
• Sterile



20 fiole x 5 ml  
20 ampoules x 5 ml

**Soluție NaCl 0.9% neinjectabilă** [20] 0928-005

• Destinată igienei nazale și oculare  
• Sterilă

**Non-injectable solution NaCl 0.9%**

• For nasal and ocular hygiene  
• Sterile



## G371 Fașe Elastice de Fixare • Elastic Fixation Bandages

### Fașă Elastică

1117

- Uz tehnico-medical - fașă compresivă cu înalt grad de elasticitate, care permite aerisirea zonei pansate.
- Este utilizată în medicină ca bandaj pentru vene varicoase, răni, întinderi de tendoane și ca material pentru pansamente.
- Pansarea nu va împiedica circulația sângelui în locul compresiei.

### Elastic Bandages

- Techno-medical use - compression bandages with high elasticity which allows the ventilation of bandaged area.
- It is used in medicine as a dressing for varicose veins, wounds, tendons stretch and as a dressing material.
- Dressing will not stop blood circulation in the compressed area.



5 x 4 cm

72

6 x 4 cm

10

8 x 4 cm

10

## G090 Bandaje Elastice • Elastic Bandages



5 cm x 4.5 m

720



7.5 cm x 4.5 m

480



10 cm x 4.5 m

360



15 cm x 4.5 m

240



20 cm x 4.5 m

180

### Bandaj Elastic

0160

- Țesătură cu elasticitate excepțională, utilizată în cazul luxațiilor, contuziilor, al tratamentului post operator al fracturilor sau ca bandaj de compresie. Compoziție: 35% cauciuc, 27% poliamidă, 38% polyester. Bandajul nu creează disconfort, acesta plindu-se pe contururile corpului.

- Dimensiune restrâns - 1,5 m; Coeficient elasticitate - 300%;

### High elastic bandages natural colour

- Fabric with exceptional elasticity, used in case of sprains, bruises, postoperative treatment of fractures or as compression bandage. Composition: 35% rubber, 27% polyamide, 38% polyester. The bandage does not cause discomfort, enfolding on the contours of the body.

- Unstretched length: 1,5 m; Maximum stretch coefficient: 300%;



## G091 Bandaje Coezive • Elastic Bandages



### Bandaje coezive

0161

- Autoaderente. Utilizate pentru fixarea de bandaje, comprese sau atele. Utilizate în zona încheieturilor, nu alunecă.

### Cohesive Bandages

- Self-adhering. Used for fixing bandages, compresses or splint. Used in the wrist area, non-slippery.



2.5 cm x 4.5 m

576

5 cm x 4.5 m

288

7.5 cm x 4.5 m

192

10 cm x 4.5 m

144

15 cm x 4.5 m

144

## G383 Benzi Kinesiologice • Kinesiology Tapes

### Bandă exercițiu cauciuc Exercise rubber band

50 1965

- roz / pink 1500 x 150 x 0.35mm
- galben / yellow 1500 x 150 x 0.45mm
- mov / purple 1200 x 150 x 0.50mm
- albastru / blue 1500 x 150 x 0.65mm





## G081 Fașe Tifon Ghipsate • Gypsum Gauze Bandage

### Fașă ghipsată

0256

- Feși de tifon cu pulbere de gips. Nu se vor folosi fașele cu margini îndoite sau cu neregularități pentru a se evita strangularea în anumite zone de către aceste margini.
- Fașele gipsate se înmoaie în apă caldă unde stau până se saturează (nu mai ies bule de aer) apoi se scot și se storc prin ușoare mișcări de rotație pentru a elimina excesul de apă dar nu și gipsul. După înmuiere se derulează fașa gipsată uniform pe tegumentele acoperite în prealabil cu vată.

3 m x 10 cm 120  
3 m x 15 cm 120  
3 m x 20 cm 60



### Gypsum gauze bandage

- Gauze Bandages with gypsum powder. Do not use the gauzes that have bent edges or irregularities to prevent strangulation in some areas by the edges.
- The gypsum bandage is soaked in warm water till it's saturated (until there are no air bubbles) then remove it and squeeze by gentle rocking motion to remove excess water but not the gypsum. After soaking unroll the gypsum bandage evenly on teguments, which are previous covered with wool.

## G082 Vată Ortopedică • Orthopedic Wool



3 m x 10 cm 360  
3 m x 15 cm 240  
3 m x 20 cm 180

### Vată ortopedică sub fașă ghipsată

1180

- Utilizat pentru imobilizarea membrilor fracturate până la sosirea personalului medical. Material neșesut.

### Orthopedic wool

- Used to immobilize the fractured members until medical personnel arrive. Non-woven.



## G083 Accesorii Imobilizare • Immobilization accessories



96 cm  
2 buc / pcs

### Bandaj triunghiular PPSB, două laturi

125 0929

- Utilizat pentru imobilizarea membrilor fracturate până la sosirea personalului medical. Material neșesut.

### PPSB triangular bandage, two sides

- Used to immobilize the fractured limbs until medical personnel arrive. Non-woven.

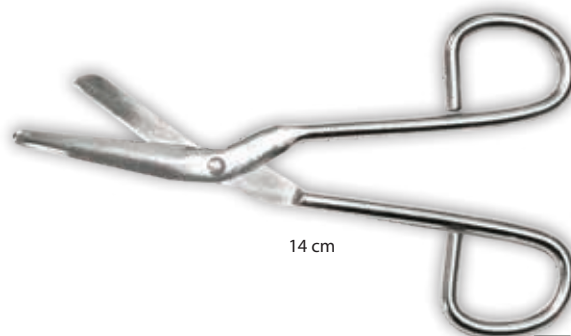

14 cm

### Foarfecă metalică lame curbe cu vârfuri boante

500 0925

- Pentru utilizarea în cazuri de imobilizare ale practicii medicale.
- Lamă tăioasă pentru material textil tip postav gros de minim 2 mm

### Wire scissors with rounded toes

- Used for immobilization in medical practice.
- Cutting blades for cloth fabric, thickness min. 2mm



4 cm  
6 buc / pcs

### Ac siguranță

- Se folosește pentru fixarea bandajelor și a fașelor.

### Safety pin

- Used for fixing bandages and gauzes.

144 0943



18.7 x 2.7 cm  
2 buc / pcs

### Atelă din material plastic

200 0930

- Folosită pentru a imobiliza în mod provizoriu membrele fracturate.

### Plastic Splint

- Used to provisionally immobilize the fractured members.



**Bețișoare bumbac cu opritor**

• Pentru copii

**Safety cotton buds**

• For children

144 0133

55 buc / pcs



**Bețișoare bambus**

**Bamboo buds**

240 0129

100 buc / pcs



100 buc / pcs

**ALINTA dischete bumbac**

**ALINTA Cotton pads**

144 0136



30 buc / pcs

**Tampoane mamare**

• Din bumbac natural, autoadezive

144 2114

**Breast pads**

• Natural cotton, self-adhesive

25 kg sac /sack

**Pudră de talc farmaceutică**

**Pharmaceutical talcum powder**

1 2071





**Plasturi PPSB pentru fixare branulă I.V.**  
 • Ambalați individual; pentru susținerea și fixarea branulelor.  
 • Sterili

24 1052



8x6cm,  
50 buc/cutie - pcs/box

**Plasters for securing I.V. cannulas**  
 • Individually packed; used for sustaining and fixing cannulas  
 • Sterile

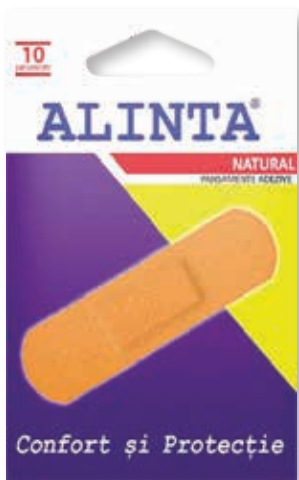

19 x 72 mm  
10 buc / pcs

**Plasturi natural standard** 50 0176  
**Natural standard plasters**



9 buc / pcs

**Plasturi asortate** 50 0168  
**Assorted plasters**



8 buc / pcs

**Plasturi forme mix** 50 0169  
**Mix shapes plasters**



19 x 60 mm  
10 buc / pcs

**Plasturi pânză ZnOX** 50 0172  
**Textile ZnOx plasters**



19 x 72 mm  
10 buc / pcs

**Plasturi hârtie** 50 0173  
**Paper plasters**



19 x 72 mm  
10 buc / pcs

**Plasturi transparente** 50 0174  
**Transparent plasters**



24 0208

2.50 cm x 2.5 m rolă / roll  
24 buc / pcs

2.50 cm x 4.5 m rolă / roll  
24 buc / pcs



24 0209

5.00 cm x 3 m rolă / roll  
12 buc / pcs

5.00 cm x 4.5 m rolă / roll  
12 buc / pcs



15 0211

2.50 cm x 5.0 m rolă / roll  
24 buc / pcs



15 0212

5.00 cm x 4.5 m rolă / roll  
12 buc / pcs

**Leucoplast hârtie**  
Medical paper adhesive tape

**Leucoplast transparent**  
Polyethylene transparent adhesive tape



15 0214

2.50 cm x 4.5 m rolă / roll  
24 buc / pcs



15 0215

5.00 cm x 4.5 m rolă / roll  
12 buc / pcs



15 0217

2.50 cm x 4.5 m rolă / roll  
24 buc / pcs



15 0218

5.00 cm x 4.5 m rolă / roll  
12 buc / pcs

**Leucoplast pânză ZnOx**  
ZnOx fabric adhesive tape

**Leucoplast mătase**  
Silk fabric adhesive tape



20 x 60 mm  
100 buc / pcs

**Plasturi pânză elastică**  
Elastic fabric adhesive plasters

100 0191



19 x 72 mm  
100 buc / pcs

**Plasturi hârtie hipoalergenic**  
Medical paper hypoallergenic adhesive plasters

100 0192



19 x 72 mm  
100 buc / pcs

**Plasturi transparente**  
Polyethylene transparent adhesive plasters

0193



19 x 72 mm  
100 buc / pcs

**Plasturi natural standard**  
Medical polyethylene skin colour adhesive plasters

0195

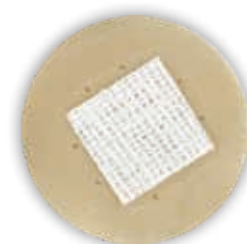

40  
22.5 mm  
200 buc / pcs  
rotund / round

**Plasturi natural rotund**  
Skin colour adhesive plasters

0196



38 x 38 mm  
200 buc / pcs  
pătrat / square

**Plasturi natural**

**Skin colour adhesive plasters**

100

0197



60 x 100 mm  
5 buc / pcs

**Plasturi pânză**

**Elastic fabric plaster**

400

0932



600 x 500 mm

**Plasturi pânză**

**Elastic fabric plaster**

100

0933



**Set plasturi asortați, sterili**

- Din poliester, adezivi
- Plasture pentru protecția degetelor 12 x 2cm - 2 buc
- Plasture pentru varful degetului 4 x 6.5cm - 4 buc
- Plasture 1.9 x 7.2cm - 2 buc
- Plasture 2.5 x 7.2cm - 4 buc
- Sterili

10 buc / pcs

10 1685

**Sterile assorted plasters**

- Polyester, adhesive
- Finger dressing 12 x 2cm - 2 pcs
- Dressing for finger tips 4 x 6.5cm - 4 pcs
- Plaster strips 1.9 x 7.2cm - 2 pcs
- Plaster strip 2.5 x 7.2cm - 4 pcs
- Sterile



5 x 10 m 100

10 x 10 m 50

15 x 10 m 50

20 x 10 m 50

**Plasture hipotalergen din nețesut, elastic**

1455

- Pentru fixarea pansamentelor pe întreaga lor suprafață
- Hypoallergenic plaster, elastic**
- From non-woven fabric, with laminated paper, for wound dressing fixation

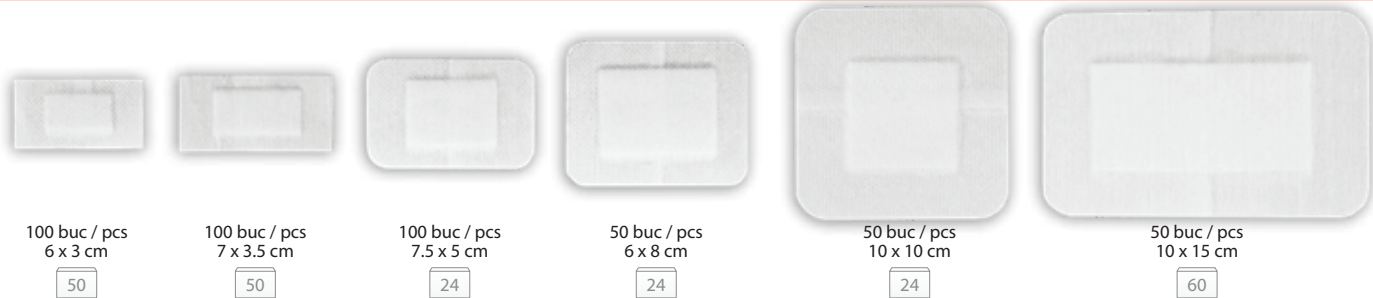

100 buc / pcs  
6 x 3 cm

50

100 buc / pcs  
7 x 3.5 cm

50

100 buc / pcs  
7.5 x 5 cm

24

50 buc / pcs  
6 x 8 cm

24

50 buc / pcs  
10 x 10 cm

24

50 buc / pcs  
10 x 15 cm

60

**Plasturi PPSB sterili**

0938

- Acoperirea rănilor după operații și prevenirea recontaminării - oferă protecție rănii timp de cca 48 de ore. Pansarea rănilor ușoare ( ex: în timpul acordării primului ajutor ). Recomandat pentru pacienții cu piele sensibilă
- Autoadeziv, pe suport de material nețesut, cu corp absorbant; oferă protecție mecanică rănii; plasturele nu se lipește de rană și se îndepărtează fără durere; materialul exterior este permeabil pentru aer și vapori de apă individual. ✓ Sterili

**Sterile nonwoven adhesive plasters**

- Cover the wound after surgery and prevent recontamination - they offer protection to the wound for ca. 48 hours. Used for dressing of minor wounds ( for ex. when offering first aid ). Recommended for patients with sensitive skin.
- Self-Adhesive, nonwoven material, with absorbent pad; mechanical protection; the plaster does not stick to the wound and can be removed without pain; the outer material is water vapour and air permeable; individually packed. ✓ Sterile



**Plasturi strip închiderea atraumatică a plăgilor mici și a inciziilor chirurgicale**

250

1458

- Din material nețesut
- Sterile

**Wound closure plature strips, for atraumatic closure of minor wounds and surgical incisions**

- Non-woven material
- Sterile

6 x 75mm - 3buc, 50 plicuri pe cutie

6 x 75mm - 3pcs per envelope, 50 envelopes per box

13 x 100mm - 3buc pe plic, 50 plicuri pe cutie

13 x 100mm - 10pcs per envelope, 50 envelopes per box





**Gel ECG & EEG & EMG & EOG în flacon dispenser 1022**

- Pentru aparate medicale de diagnostică, ca un gel conductor între electrozi și piele.
- Este folosit la Electrocardiogramă (ECG), Electroencefalogramă (EEG), Electromiografie (EMG), Electrooculogramă (EOG), Defibrilare.

**ECG & EEG & EMG & EOG liquid gel in dispenser bottle**

- For medical diagnosis devices, used as a conductive gel between the electrodes and the skin.
- Used in Electrocardiography (ECG), Electroencephalography (EEG), Electromyography (EMG), Electrooculogram, Defibrillation .



transparent  
1000 ml  
12



transparent  
260 ml  
40



**Gel ultrasunete (ecografie) & IPL 1021**

- Diagnostică medicală cu ultrasunete la ecografe pentru a lua imagini clare și pentru a lubrifia pielea.

**Ultrasound & IPL liquid gel**

- Medical diagnosis with ultrasound for echograph devices, to take clear images and lubricate the skin.



5000 ml  
4



1000 ml  
12



260 ml  
40

**Gel ultrasunete IPL 1472**

- Pentru aparatele de epilare definitivă IPL și tratamentele cu laser, unde este necesar un gel.
- Elimină aerul dintre piele și probă, permițând undelor să ajungă la aparatul de monitorizare într-un mod cât mai clar. Efectul său nu este afectat de sărurile eliminate de corp în timpul folosirii, ușurând astfel procesul.
- Inodor, hipoalergenic, nu irită pielea, nu conține substanțe uleioase, formaldehide sau săruri.

**Ultrasound IPL liquid gel**

- For IPL permanent hair removal machines and laser treatments where a gel is required.
- Removes the air between skin and sample, allowing the waves to reach the eliminated during usage.
- Odorless, hypoallergenic, does not irritate the skin, does not contain oily substances, formaldehyde or salt.



5000 ml  
4



1000 ml  
12



transparent  
1000 ml

**Gel lubrifiant transparent 1196**

- Pentru aplicarea pe mâini, brațe sau mănuși înainte de procedurile obstetricale, examene rectale și vaginale, trecerea de instrumente, manieri și investigații.

**Lubricant gel**

- Used for medical diagnosis devices, used as a conductive gel between the electrodes and the skin. It is used in Electrocardiography (ECG), Electroencephalography (EEG), Electromyography (EMG), Electrooculogram, Defibrillation .

**Pastă EEG - Electroencefalografie 1197**

- Gel foarte conductiv, special formulat pentru a lipi electrozi pe piele

**EEG paste - Electroencephalography**

- Highly conductive gel, specially formulated to stick the electrodes on the skin



400 gr



**Gel lubrifiant transparent 1198**

- Steril
- Se utilizează pentru endoscopie, colonoscopie, examinări ginecologice, aplicații de rectoscopie, aplicații de sunet pe lângă lubrifierea vaginală

**Lubricant, transparent gel pouch**

- Sterile
- It is used for endoscopy, colonoscopy, gynaecological examinations, rectoscopy applications, sound applications in addition to vaginal lubrication.

plic/pouch 5 gr  
100 buc / pcs





**Hârtie ECG termică - rolă**  
**ECG Thermal paper - roll**

1078



Cod / Code	ECG producător și model / manufacturer and model	Lățime W (mm)	Lungime H (m)	Caroiaj / Grid	Cantitate / Order
1078-58x20-5	BS ECO	58	25	roșu/red	5 role/rolls
1078-58x25-5	BS ECO	58	25	roșu/red	5 role/rolls
1078-112x25-5	B56 / A4	112	25	roșu/red	5 role/rolls



Cod / Code	ECG producător și model / manufacturer and model	Lățime W (mm)	Lungime H (m)	Caroiaj / Grid	Cantitate / Order
1078-112x25-5	BCM 600	112	25	roșu/red	5 role/rolls



Cod / Code	ECG producător și model / manufacturer and model	Lățime W (mm)	Lungime H (m)	Caroiaj / Grid	Cantitate / Order
1078-80x20-5	IE300	80	20	roșu/red	5 role/rolls
1078-210x30-5	IE1200	210	30	roșu/red	5 role/rolls



Cod / Code	ECG producător și model / manufacturer and model	Lățime W (mm)	Lungime H (m)	Caroiaj / Grid	Cantitate / Order
1078-110x20-5	3500	110	20	roșu/red	5 role/rolls
1078-110x30-5	3500	110	30	roșu/red	5 role/rolls
1078-210x30-5	8000	210	30	roșu/red	5 role/rolls



Cod / Code	ECG producător și model / manufacturer and model	Lățime W (mm)	Lungime H (m)	Caroiaj / Grid	Cantitate / Order
1078-63x30-5	EKG 601	63	30	roșu/red	5 role/rolls
1078-120x30-5	EKG 503V	120	30	roșu/red	5 role/rolls



Cod / Code	ECG producător și model / manufacturer and model	Lățime W (mm)	Lungime H (m)	Caroiaj / Grid	Cantitate / Order
1078-58x20-5	08S*, 08S1/S3SD	58	20	roșu/red	5 role/rolls
1078-112x25-5	08 M PLUS	112	25	roșu/red	5 role/rolls
1078-210x25-5	08 LT/LT	210	25	roșu/red	5 role/rolls
1078-210x30-5	08 LT/LT	210	30	roșu/red	5 role/rolls



Cod / Code	ECG producător și model / manufacturer and model	Lățime W (mm)	Lungime H (m)	Caroiaj / Grid	Cantitate / Order
1078-50x20-5	EK10	50	20	roșu/red	5 role/rolls



Cod / Code	ECG producător și model / manufacturer and model	Lățime W (mm)	Lungime H (m)	Caroiaj / Grid	Cantitate / Order
1078-120x30-5	Excel-103, Excel-106	120	30	roșu/red	5 role/rolls
1078-210x20-5	AR 2100	210	20	roșu/red	5 role/rolls
1078-210x25-5	AR 2100	210	25	roșu/red	5 role/rolls



Cod / Code	ECG producător și model / manufacturer and model	Lățime W (mm)	Lungime H (m)	Caroiaj / Grid	Cantitate / Order
1078-50x20-5	Delta-1	50	20	roșu/red	5 role/rolls
1078-50x30-5	E-1, ETA-150	50	30	roșu/red	5 role/rolls
1078-60x30-5	Delta-1 Plus	60	30	roșu/red	5 role/rolls
1078-120x30-5	ETA System	120	30	roșu/red	5 role/rolls
1078-210x20-5	Delta-60 Plus	210	20	roșu/red	5 role/rolls
1078-210x25-5	Delta-60 Plus	210	25	roșu/red	5 role/rolls
1078-210x30-5	Delta-60 Plus	210	30	roșu/red	5 role/rolls



Cod / Code	ECG producător și model / manufacturer and model	Lățime W (mm)	Lungime H (m)	Caroiaj / Grid	Cantitate / Order
1078-50x30-5	ECG 100/ CMS6000	50	30	roșu/red	5 role/rolls
1078-80x20-5	ECG300G	80	20	roșu/red	5 role/rolls
1078-110x20-5	ECG600G	110	20	roșu/red	5 role/rolls



Cod / Code	ECG producător și model / manufacturer and model	Lățime W (mm)	Lungime H (m)	Caroiaj / Grid	Cantitate / Order
1078-80x20-5	Smart SE-3, SE 3/300	80	20	roșu/red	5 role/rolls
1078-210x30-5	SE-6/ SE-12/ SE-600	210	30	roșu/red	5 role/rolls



Cod / Code	ECG producător și model / manufacturer and model	Lățime W (mm)	Lungime H (m)	Caroiaj / Grid	Cantitate / Order
1078-50x30-5	Doc-101	50	30	roșu/red	5 role/rolls
1078-120x20-5	Excel-106	120	20	roșu/red	5 role/rolls
1078-120x30-5	Excel-106	120	30	roșu/red	5 role/rolls



Cod / Code	ECG producător și model / manufacturer and model	Lățime W (mm)	Lungime H (m)	Caroiaj / Grid	Cantitate / Order
1078-50x30-5	Biomedica Personal C1	50	30	roșu/red	5 role/rolls



Cod / Code	ECG producător și model / manufacturer and model	Lățime W (mm)	Lungime H (m)	Caroiaj / Grid	Cantitate / Order
1078-50x20-5	501-D/ S/ SA	50	20	roșu/red	5 role/rolls
1078-50x30-5	Cardisuny 501-D/ S/ SA	50	30	roșu/red	5 role/rolls
1078-63x30-5	FCP11/FCP15/FCP215S, FX2111	63	30	roșu/red	5 role/rolls
1078-112x25-5	ECG-1106	112	25	roșu/red	5 role/rolls
1079-130x30-5	503 A, D / P / S	130	30	roșu/red	5 role/rolls
1078-145x30-5	FCP145	145	30	roșu/red	5 role/rolls
1078-210x30-5	FCP231, FCP231A5	210	30	roșu/red	5 role/rolls

**HELLIGE**

Cod / Code	ECG producător și model / manufacturer and model	Lățime W (mm)	Lungime H (m)	Caroiaj / Grid	Cantitate / Order
1078-50x30-5	SMR 200	50	30	roșu/red	5 role/rolls
1078-55x20-5	EK 41/51	55	20	roșu/red	5 role/rolls
1078-110x30-5	EK 26/27T	110	30	roșu/red	5 role/rolls
1078-130x50-5	EK 33/43	130	50	roșu/red	5 role/rolls

**HÖRMANN MEDIZIN**

Cod / Code	ECG producător și model / manufacturer and model	Lățime W (mm)	Lungime H (m)	Caroiaj / Grid	Cantitate / Order
1078-210x30-5	Bioset 8000	210	30	roșu/red	5 role/rolls

**Kalamed**  
Medical Systems

Cod / Code	ECG producător și model / manufacturer and model	Lățime W (mm)	Lungime H (m)	Caroiaj / Grid	Cantitate / Order
1078-112x25-5	KES-601T	112	25	roșu/red	5 role/rolls

**Kenz.**

Cod / Code	ECG producător și model / manufacturer and model	Lățime W (mm)	Lungime H (m)	Caroiaj / Grid	Cantitate / Order
1078-50x30-5	ECG-103/106/107/108	50	30	roșu/red	5 role/rolls
1078-210x30-5	Cardico-1201	30	30	roșu/red	5 role/rolls

**medical ECONET**

Cod / Code	ECG producător și model / manufacturer and model	Lățime W (mm)	Lungime H (m)	Caroiaj / Grid	Cantitate / Order
1078-210x30-5	Cardio-M-Plus	210	30	roșu/red	5 role/rolls

**MEDICOR**

Cod / Code	ECG producător și model / manufacturer and model	Lățime W (mm)	Lungime H (m)	Caroiaj / Grid	Cantitate / Order
MR 11		50	30	roșu/red	5 role/rolls

**mindray**

Cod / Code	ECG producător și model / manufacturer and model	Lățime W (mm)	Lungime H (m)	Caroiaj / Grid	Cantitate / Order
DECG-03A		80	20	roșu/red	5 role/rolls

**Mortara**

Cod / Code	ECG producător și model / manufacturer and model	Lățime W (mm)	Lungime H (m)	Caroiaj / Grid	Cantitate / Order
1078-210x20-5	Eli-230	210	20	roșu/red	5 role/rolls

**NIHON KOHDEN**

Cod / Code	ECG producător și model / manufacturer and model	Lățime W (mm)	Lungime H (m)	Caroiaj / Grid	Cantitate / Order
1078-50x20-5	WT811PA/617P/711	50	20	roșu/red	5 role/rolls
1078-50x30-5	ECG6101/6151/6501, ECG6511/WT811PA, ECG6551/TEC7000	50	30	roșu/red	5 role/rolls
1078-63x30-5	ECG8110, ECG1150	63	30	roșu/red	5 role/rolls

**PHYSIO CONTROL**

Cod / Code	ECG producător și model / manufacturer and model	Lățime W (mm)	Lungime H (m)	Caroiaj / Grid	Cantitate / Order
1078-50x30-5	Lifepack-6/7/8/9/10	50	30	roșu/red	5 role/rolls

**SCHILLER**  
THE ART OF DIAGNOSTICS

Cod / Code	ECG producător și model / manufacturer and model	Lățime W (mm)	Lungime H (m)	Caroiaj / Grid	Cantitate / Order
1078-130x50-5	Cardiovit-3	130	50	roșu/red	5 role/rolls

**SIEMENS**

Cod / Code	ECG producător și model / manufacturer and model	Lățime W (mm)	Lungime H (m)	Caroiaj / Grid	Cantitate / Order
1078-50x30-5	Cardiostat-1, Sirecust 341	50	30	roșu/red	5 role/rolls
1078-110x30-5	Cardiostat-3T	110	30	roșu/red	5 role/rolls

**TRIS MED**  
Cardiac Diagnosis Systems

Cod / Code	ECG producător și model / manufacturer and model	Lățime W (mm)	Lungime H (m)	Caroiaj / Grid	Cantitate / Order
1078-110x30-5	Cardipia 400	110	30	roșu/red	5 role/rolls







**Hârtie ECG termică - foaie**  
**ECG Thermal paper - sheet**

1337



Cod / Code	ECG producător și model / manufacturer and model	Lățime W (mm)	Lungime H (m)	Caroiaj / Grid	Cantitate / Order
1337-152x90x150-1	IC 90	152	90	roșu/red	150 coli/sheets



Cod / Code	ECG producător și model / manufacturer and model	Lățime W (mm)	Lungime H (m)	Caroiaj / Grid	Cantitate / Order
1337-110x100x150-1	3600/3700	110	100	roșu/red	150 coli/sheets



Cod / Code	ECG producător și model / manufacturer and model	Lățime W (mm)	Lungime H (m)	Caroiaj / Grid	Cantitate / Order
1337-210x280x200-1	AR 2100	210	280	roșu/red	200 coli/sheets

**HELLIGE**

Cod / Code	ECG producător și model / manufacturer and model	Lățime W (mm)	Lungime H (m)	Caroiaj / Grid	Cantitate / Order
1337-80x90x280-1	Contrast	80	280	roșu/red	280 sheets/coli
1337-210x295x150-1	Cardiosmart 1200/1600	210	150	roșu/red	150 sheets/coli

**CARDIOLINE**

Cod / Code	ECG producător și model / manufacturer and model	Lățime W (mm)	Lungime H (m)	Caroiaj / Grid	Cantitate / Order
1337-112x100x300-1	Delta-3 Plus	112	100	roșu/red	300 sheets/coli
1337-210x280x200-1	Delta-60 Plus	210	280	roșu/red	200 sheets/coli



Cod / Code	ECG producător și model / manufacturer and model	Lățime W (mm)	Lungime H (m)	Caroiaj / Grid	Cantitate / Order
1337-210x300x100-1	Page Writer Trim	210	300	roșu/red	100 sheets/coli



Cod / Code	ECG producător și model / manufacturer and model	Lățime W (mm)	Lungime H (m)	Caroiaj / Grid	Cantitate / Order
1337-210x140x250-1	Cardico-1211	210	140	roșu/red	250 sheets/coli

**MARQUETTE**

Cod / Code	ECG producător și model / manufacturer and model	Lățime W (mm)	Lungime H (m)	Caroiaj / Grid	Cantitate / Order
1337-80x90x280-1	MAC 400/ MAC600	80	90	roșu/red	280 sheets/coli
1337-210x280x300	Case 12/15	210	280	roșu/red	300 sheets/coli

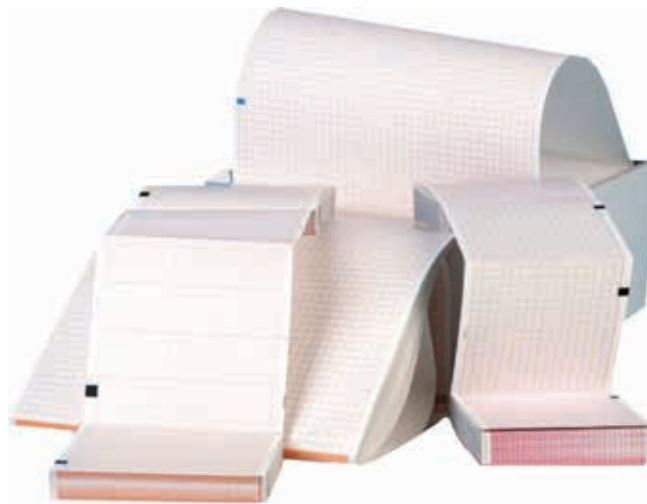

**COMEN**

Cod / Code	ECG producător și model / manufacturer and model	Lățime W (mm)	Lungime H (m)	Caroiaj / Grid	Cantitate / Order
1337-112x90x150-1	Star 5000/5000C	112	90	roșu/red	150 sheets/coli



Cod / Code	ECG producător și model / manufacturer and model	Lățime W (mm)	Lungime H (m)	Caroiaj / Grid	Cantitate / Order
1337-152x90x150-1	Series 115/116/118/120	152	90	roșu/red	150 sheets/coli



Cod / Code	ECG producător și model / manufacturer and model	Lățime W (mm)	Lungime H (m)	Caroiaj / Grid	Cantitate / Order
1337-110x140x140-1	SE-601	110	140	roșu/red	140 sheets/coli
1337-112x90x150-1	Cadence MFM2	112	90	roșu/red	150 sheets/coli
1337-210x295x150-1	MSI	210	295	roșu/red	150 sheets/coli



Cod / Code	ECG producător și model / manufacturer and model	Lățime W (mm)	Lungime H (m)	Caroiaj / Grid	Cantitate / Order
1337-80x70x315-1	Biomedica P-8000 Base	80	70	roșu/red	315 sheets/coli
1337-90x70x400-1	Biomedica P-80	90	70	roșu/red	400 sheets/coli



Cod / Code	ECG producător și model / manufacturer and model	Lățime W (mm)	Lungime H (m)	Caroiaj / Grid	Cantitate / Order
1337-110x140x140-1	OP-222TE	110	140	roșu/red	140 sheets/coli



Cod / Code	ECG producător și model / manufacturer and model	Lățime W (mm)	Lungime H (m)	Caroiaj / Grid	Cantitate / Order
1337-50x100x300-1	FQW50-3-100	50	100	roșu/red	300 coli/sheets
1337-110x140x143-1	ECG9010 / ECG9020	110	140	roșu/red	143 coli/sheets



Cod / Code	ECG producător și model / manufacturer and model	Lățime W (mm)	Lungime H (m)	Caroiaj / Grid	Cantitate / Order
1337-70x100x200-1	AT-3	70	100	roșu/red	200 coli/sheets
1337-90x90x400-1	AT-1	90	90	roșu/red	400 coli/sheets
1337-210x140x250-1	AT-10	210	140	roșu/red	250 coli/sheets
1337-210x280x215-1	AT-2 PLUS	210	280	roșu/red	215 coli/sheets



Cod / Code	ECG producător și model / manufacturer and model	Lățime W (mm)	Lungime H (m)	Caroiaj / Grid	Cantitate / Order
1337-210x280x200-1	CP100/200, CP100	210	280	roșu/red	200 coli/sheets

Acumulator compatibil cardiograf  
Compatible battery

50 2327



voltaj / voltage 9.6V,  
3Ah,  
0.456 kg

• BIOSET 3500-HORMANN Ni-Mh

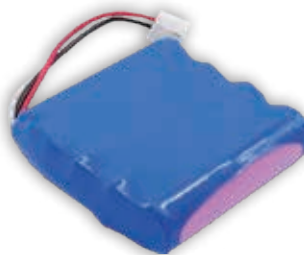

voltaj / voltage 14.4V,  
2.6Ah,  
0.195 kg

• COMEN 1200B Li-Ion,



voltaj / voltage 6V,  
4Ah

• Siemens MEGACART



voltaj / voltage 12V,  
2.3Ah,  
0.830 kg

• MORTARA ELI 250 Lead



voltaj / voltage 12V,  
1.2Ah

• BTL 08MT, voltaj 12V, 1.2Ah



voltaj / voltage 10.8V,  
0.7Ah,  
0.189 kg

• GE Hellige EK51 Ni-Cd



voltaj / voltage 12V,  
2.3Ah,  
178x x34 x 64 mm

• Esaote P80 Plumb



voltaj / voltage 9.6V,  
2.5Ah,  
0.480 kg

• BIOSET 3600 - HORMANN NI-CD



voltaj / voltage 14.8V,  
2.6Ah,  
0.200 kg

• EDAN SE-1200 Li-Ion



voltaj / voltage 6V,  
3.5Ah,  
0.750 kg

• GE Hellige EK31 - EK33 Lead

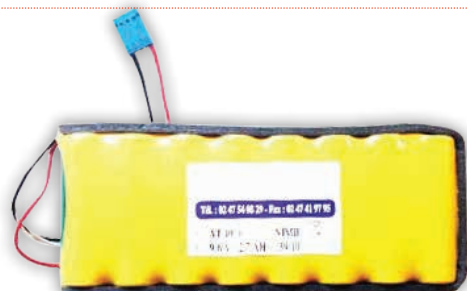

voltaj / voltage 9.6V,  
2.1Ah,  
0.320 kg

• SCHILLER AT10 Plus Ni-Mh



voltaj / voltage 24V,  
1Ah,  
0.120 kg

• CARDIOLINE DELTA 1+ / 3+, Ni-Cd



36 x 45mm

**Electrozi ECG unică folosință**

40 1020

- Sunt folosiți în cadrul tuturor secțiilor din spitale, clinici, incluzând secții de terapie intensivă și servicii de ambulanță. Electrozi EKG de unică folosință din Ag/AgCl cu hidrogen solid material suport spumă.
- Electrozii au o aplicare ușoară pe diferite zone anatomice. Sunt potriviți atât pentru EKG de efort, repaus și monitorizarea Holterului de ritm. Sunt potriviți pentru toate tipurile de piele. Adezivi, neiritanți pentru piele sau utilizatori, imperceptibili proiecțai să diminueze reacțiile alergice. Buni conducători electrici. Nesterili. Fără latex. Formă ovală.

**Electrodes for ECG, disposable**

- Used in all hospital departments, clinics including intensive care units and ambulance services. Disposable ECG electrodes with solid gel, Silver/Silver Chloride (SSC) sensor. Suitable for all skin types.
- The electrodes are easy to apply to different anatomical areas. They are suitable for the exercise, rest and rhythm ECG and Holter rhythm monitoring. Adhesive, not-irritant to skin or users, designed to reduce allergic reactions. Good electric conductivity. Non-sterile. Latex-free. Oval shape.



32 x 32mm  
50 buc

**Electrozi ECG de unică folosință**

20 2031

- Parte activă cu clorură de argint
- ECG electrodes for single use**
- Active part with silver chloride



6 buc/pcs

**Electrozi universali ECG periferici tip ventuză**

10 1019

- Din plastic și parte metalică acoperită cu argint / clorură de argint
- Diametru bilă: 33 mm, diametru parte metalică: 24 mm

**Peripheral suction chest electrodes for ECG**

- Made of plastic and a metal part, coated with silver/silver chloride
- Ball diameter: 33 mm, diameter of the metal part: 24 mm



30 x 130 mm  
1 set  
adulți / adults

20 x 85 mm  
1 set  
copii / children

**Electrozi ECG periferici tip clește, reutilizabili**

10 1018

- Din plastic și parte metalică acoperită cu argint / clorură de argint, mărime universală
- Roșu, verde, galben, negru

**Peripheral clamp electrodes for ECG, reusable**

- Made of plastic and a metal part, coated with silver/ silver chloride, universal size
- Red, green, yellow, black



4 buc / pcs  
31.5 x 22 mm  
adulți / adults

4 buc / pcs  
20 x 15 mm  
copii / children

**Electrozi ECG periferici plăți**

10 1549

- Metal acoperit cu argint, mărime universală

**Plate electrodes for ECG**

- Made of metal coated with silver, universal size

<b>Cabluri EKG</b> <b>EKG Cable</b>			
<b>corpuls<sup>3</sup></b>	Compatibilitate / Compatibility	Nr. fire/ wire	Cantitate/ Order
1765-01	Corpuls 3	6	1 set

<b>NIHON KOHDEN</b>			
1765-02	Nihon Kohden	3	1 set
<b>EDAN INSTRUMENTS</b>			
1765-03	EDAN	3	1 set
1765-04	EDAN SE 600	10	1 set



Cablu EKG cu 6 fire pentru defibrilator Corpuls 10 1765-01  
6 wier EKG cable for CORPULS



Cablu EKG cu 3 fire Mindray 10 1765-03  
EKG cable for electrocardiograph EDAN with 3 wire



Cabluri EKG cu 3 fire pentru Nihon Kohden 10 1765-02  
3 wire EKG cable for EKG Nihon Kohden



Cablu EKG cu 10 fire EDAN SE 600 10 1765-04  
EKG cable for electrocardiograph EDAN SE 600 with 10 wire



high density compatibilă/compatible high density



standard compatibilă/compatible standard



high density glossy compatibilă/glossy high density compatible

**Hârtie termică - compatibilă video printer Sony/Mitsubishi**  
**Thermal paper - compatible with Sony/Mitsubishi video printer**

40 1104



standard compatibilă/compatible standard



high density compatibilă/compatible high density

coroiaj roșu/red grid  
 For Video Printer SONY/MITSUBISHI  
 110mm x 20 m

**Hârtie termică - compatibilă video printer Sony/Mitsubishi**  
**Thermal paper - compatible with Sony/Mitsubishi video printer**

40 1079



high density compatibilă/compatible high density



standard compatibilă/compatible standard



high density glossy/glossy high density

**Hârtie termică - compatibilă video printer Sony**  
**Thermal paper - compatible with Sony video printer**

100 1090

**Clește nas pentru spirometrie** 100 1880  
**Nose clip for spirometry**



**Piesă bucală spirometrie** 500 1310  
**Spirometry mouthpiece**

Cod / Code	Compatibilitate / Compatibility	Marime / Size int. x ext. (mm)	Cantitate / Order
1310-TS8248	SIBEL, BTL	26,2 x 28	1buc/pc
<b>SIBEL</b>			
1310-TS8248	SIBEL, BTL	26,2 x 28	1buc/pc
<b>MIR</b>			
1310-TS3962	MIR, VITALOGRAPH CONTEC, VIASYS, MICROMEDICAL	28 x 30	1buc/pc
<b>Vitalograph</b>			
1310-TS3962	MIR, VITALOGRAPH CONTEC, VIASYS, MICROMEDICAL	28 x 30 f04923	1buc/pc
<b>FUKUDA DENSHI</b>			
1310-TS9190	SORIN LIFEWATCH, FUKUDA DENSHI	24.2 x 26	1buc/pc



- Unică folosință
- Carton
- Ambalate individual
- Disposable
- Cardboard
- Individually wrapped

**Filtru bacterian viral spirometru** 500 1315  
**Bacterial viral filter for spirometry**

Cod / Code	Compatibilitate / Compatibility	Marime / Size int. x ext. (mm)	Cantitate / Order
1315-MAX30	MIR, VITALOGRAPH CONTEC, VIASYS, MICROMEDICAL	27/27.5 x 30/30	1buc/pc
<b>Vitalograph</b>			
1315-MAX30	MIR, VITALOGRAPH CONTEC, VIASYS, MICROMEDICAL	27/27.5 x 30/30	1buc/pc
<b>MIR</b>			
1315-MAX30	MIR, VITALOGRAPH CONTEC, VIASYS, MICROMEDICAL	27/27.5 x 30/30	1buc/pc



G285 Hârtie Spirometrie & Audiometrie • Spirometry & Audiometry Paper



**Hârtie termică** 1311  
 • Necaroiată pentru monitoare funcții vitale, alte aparate medicale  
**Thermal paper**  
 • Plain, for monitor of vital signs and other medical devices

**Rolă termică pentru aparate de taxi** 196 1564  
**Taxi meter thermal roll**



**Rolă termică pentru case de marcat** 1700  
**Thermal cash register roll**

<b>micromedical solutions</b>			
1310-TS3962	MIR, VITALOGRAPH CONTEC, VIASYS, MICROMEDICAL	28 x 30	1buc/pc
<b>FUKUDA SANGYO</b>			
1310-TS3963	FUKUDA SANGYO, MEDICAL GRAPHICS, BIOMEDIN	25.3 x 27	1buc/pc
<b>MEDICAL GRAPHICS</b>			
1310-TS3963	FUKUDA SANGYO, MEDICAL GRAPHICS, BIOMEDIN	25.3 x 27	1buc/pc
<b>SORIN LIFE WATCH</b>			
1310-TS9190	SORIN LIFEWATCH, FUKUDA DENSHI	24.2 x 26	1buc/pc
<b>KoKo®</b>			
1310-TS8822	VB-FILTERS, THOR	25.4 x 26.8	1buc/pc
<b>SensorMEDICS</b> A subsidiary of GANSHORN			
1310-TS8182	SENSOR MEDICS, MICROGARD, GANSHORN	30.3 x 33	1buc/pc
<b>MIOCARD</b>			
1310-TS8182	SENSOR MEDICS, MICROGARD, GANSHORN	30.3 x 33	1buc/pc

<b>COSMED</b> The Medical Company			
1315-MAX33	COSMED, JAEGER CUSTOMED, GANSHORN	27/29.5 x 30/32.8	1buc/pc
<b>custo-med</b> EQUIPAMENTI EMBIMEDICAL			
1315-MAX33	COSMED, JAEGER CUSTOMED, GANSHORN	27/29.5 x 30/32.8	1buc/pc
<b>SensorMEDICS</b> A subsidiary of GANSHORN			
1315-MAX35	SENSORMEDICS, BTL, CHEST, MORGAN, MICROGARD, THOR	27/30.5 x 30/34.5	1buc/pc
<b>BTL</b>			
1315-MAX35	SENSORMEDICS, BTL, CHEST, MORGAN, MICROGARD, THOR	27/30.5 x 30/34.5	1buc/pc
<b>KoKo®</b>			
1315-MAX48	KOKO	27/45.5 x 30/48	1buc/pc

**Șorț radioprotecție frontală**  
**X-ray front protection apron**

5 1810



echivalent Pb 0,50mm,  
 60x90 cm (lățime x lungime),  
 albastru / turquoise

equivalent Pb 0,50mm,  
 60x90 cm (width x length),  
 blue/turquoise

echivalent Pb 0,50mm,  
 70x110 cm (lățime x lungime),  
 albastru / turquoise

equivalent Pb 0,50mm,  
 70x110 cm (width x length),  
 blue/turquoise

**Mănuși radioprotecție**  
**X-ray protective glove**

5 1811

mărime universală  
 echivalent 0,50 mm Pb,  
 albastru/turquoise

universal size  
 equivalent 0,50 mm Pb,  
 blue/turquoise



mărime universală  
 echivalent 0,25 / 0,35 mm Pb

universal size  
 equivalent 0,25 / 0,35 mm Pb



**Guler radioprotecție glandă tiroidă**  
**X-ray protective thyroid collar**

5 1809

echivalent Pb 0.5 mm,  
 albastru/turquoise

equivalent Pb 0.5 mm,  
 blue/turquoise



**Vestă protecție radiologică**  
**Radiation protection vest**

5 2453



mărimea XL,  
 umerii căptușiți,  
 închidere tip scai,  
 echivalent Pb 0,50mm

size XL,  
 shoulders designed for  
 same weight distribution,  
 equivalence Pb 0,50mm



0.50/0.25mm Pb,  
 mărime L,  
 lungime 60 cm

0.50/0.25mm Pb,  
 size L,  
 length 60 cm

**Șorț chirurgical protecție radiologică**  
**Surgical apron radiation protection**

5 2452



0.50mm Pb,  
 65x90 cm (latime x lungime),  
 albastru/turquoise

0.50mm Pb,  
 65x90 cm (width x length),  
 blue/turquoise

0.50mm Pb,  
 75x110 cm (latime x lungime),  
 albastru/turquoise

0.50mm Pb,  
 75x110 cm (width x length),  
 blue/turquoise

**Fustă protecție radiologică**  
**Radiation protection apron**

5 2454



0.50/0.25mm Pb,  
 mărime M,  
 lungime 60 cm

0.50/0.25mm Pb,  
 size M,  
 length 60 cm

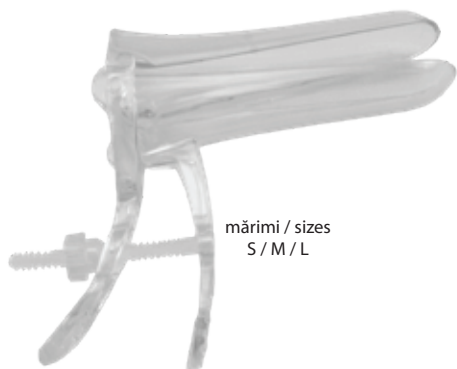

mărimi / sizes  
S / M / L

**Speculum vaginal**

- Cu opritor central
- Sterile

**Vaginal speculum with side screw**

- With middle screw
- Sterile

100 1033

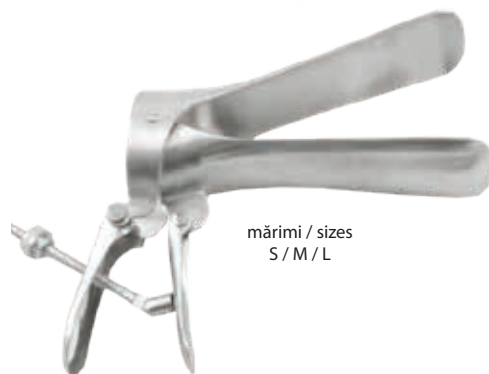

mărimi / sizes  
S / M / L

**Speculum vaginal**

- Din inox nonmagnetic
- Sterile

**Vaginal speculum with side screw**

- Nonmagnetic stainless steel
- Sterile

10 1446



lungime / length: 9 cm  
lățime / width: 4 cm  
lungime mâner / handle length: 14.5 cm

**Valvă vaginală Eastman**

- Inox
- Eastman vaginal retractor**
- Stainless steel

2011



lungime / length: 9 cm  
lățime / width: 4.5 cm  
lungime mâner / handle length: 22.5 cm

**Valvă vaginală Doyen**

- Inox
- Doyen vaginal retractor**
- Stainless steel

2012



lungime / length: 7.5 cm  
lățime / width: 3.3 cm  
lungime mâner / handle length: 15.5 cm

**Valvă vaginală Kristeller**

- Inox
- Kristeller vaginal retractor**
- Stainless steel

2013



50 buc / pcs

**Periuță recoltare endo cervicală**

- Capat detașabil
- Sterile

**Endo cervical brush with nylon**

- Removable tip
- Sterile

50 1031



50 buc / pcs

**Periuțe recoltare cervicală brăduț, PE**

- Sterile

**Cervical brushes with PVC, EO**

- Sterile

30 1032





**Sterilet intrauterin TCu380A / TCu375A - în formă de T / U** 10 1429

- Cu fir spiralat și colier din cupru
- Dispozitiv contraceptiv intrauterin din plastic și/sau metal, care are forma literei T, plasat în uter pentru a preveni sarcina. DIU este o modalitate reversibilă de control a nașterii. Se recomandă înlocuirea steriletului la cel mult 8 ani de la data montării.

**Intrauterine copper contraceptive TCu380A / TCu375A - T / U shaped**

- With copper wire
- Intrauterine copper contraceptive from plastic and/or metal, T shaped, placed into the uterus to prevent a pregnancy. IUD is a reversible method of contraception. It is recommended that the unit be replaced at a maximum of 8 years from the date when it was first inserted



**Set pentru inserarea și îndepărtarea steriletului** 10 2117

- 1 pensă de col Pozzi, 1 foarfecă Littauer, 1 pensă lungă
- Kit for IUD insertion and removal**
- 1 Evolution Pozzi forceps, 1 long Littauer scissors, 1 Evolution long forceps

G149 Teste Sarcină & Ovulație • Pregnancy & Ovulation Tests



2.5 mm

**Test sarcină HCG urină** 8000 0001  
**HCG pregnancy test, for urine**



4 mm

**Test sarcină HCG urină** 2000 0001  
**casetă**  
**HCG pregnancy test, for urine**  
**cassette**



3 mm

**Test ovulație LH urină** 8000 0772  
**LH ovulation test, for urine**

G105 Produse Proctologie • Proctology Products

G316 Canule Rectale • Rectal Cannula



Diametru parte superioara 5 cm, diametru parte inferioara 2 cm  
Upper part diameter 5 cm, lower part diameter 2 cm

**Speculum rectal unică folosință** 100 1194  
• Sterile  
**Disposable rectal speculum**  
• Sterile



CH18 (roșu/red), CH20 (galben/yellow)  
CH22 (mov/purple), CH25 (albastru/blue)  
Ch28 (verde/green), CH30 (gri/grey)

**Canulă rectală, corp cilindric, doi ochi laterali** 500 1375  
• Se folosește pentru clismă.  
**Rectal, cannula, cylindrical body, 2 lateral eyes**  
• Used for enema.



7 mm x 20 cm  
8 mm x 20 cm  
9 mm x 20 cm

10 mm x 20 cm  
11 mm x 20 cm  
12 mm x 20 cm

**Canulă aspirație chiuretaj rigidă**  
**Suction canulla curette rigid type**

20 1767



28 mm / 30 mm

100 buc / pcs  
alb / white

**Cleme ombilicale ambalate individual**  
• Sterile  
**Umbilical cord clamps, individually packed**  
• Sterile

20 1445

G350 Benzi de Identificare • Identification Bracelets



100 buc / pcs  
24.5 cm  
roz / pink

**Brățări identificare pentru adulți - inserție carton** 50 1034  
**Identification Bracelets for Adults - paper insertion**

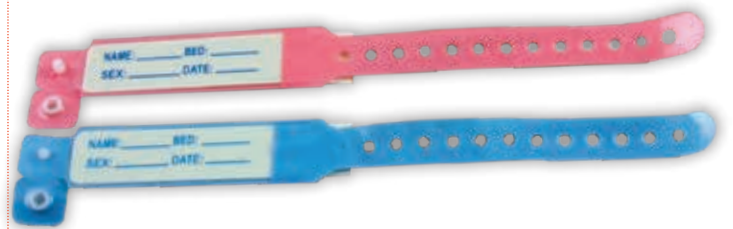

100 buc / pcs  
17.5 cm  
albastru - băieți / blue - boys  
roz - fetițe / pink - girls

**Brățări identificare pentru copii - inserție carton** 50 1035  
**Identification Bracelets for Children - paper insertion**

G047 Port Ac Suturi Chirurgicale • Surgical Needle Holders

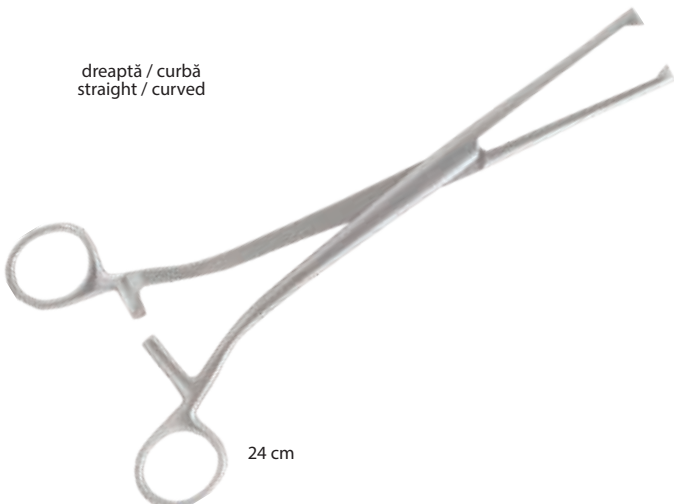

dreaptă / curbă  
straight / curved

24 cm

**Pensă urinară Museux** 10 2230  
• Inox  
**Uterine forceps Museux**  
• Stainless steel

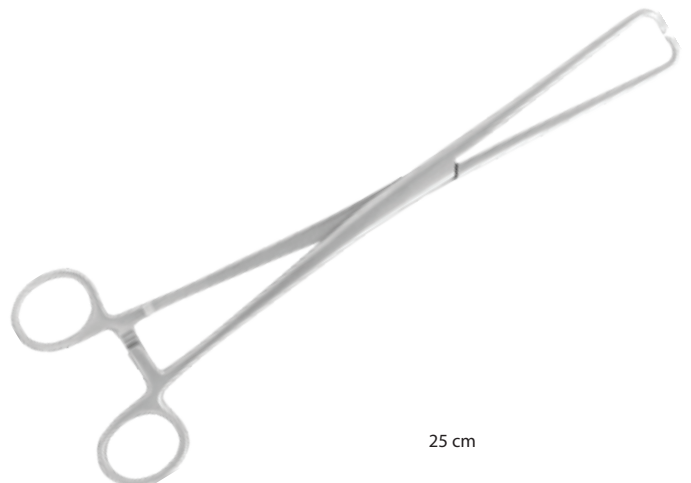

25 cm

**Pensă col uterina, Pozzi** 10 2231  
• Inox  
**Uterine cervical forceps, Pozzi**  
• Stainless steel



**Balon de resuscitare din PVC pentru adulți** 10 1532-5

- De unică folosință, în pungă plastic, 1 set
- Prevăzut cu tub oxigen 200cm, mască oxigen nr.5 și sac rezervor capacitate 1600 ml

**Manual resuscitator made of PVC, for adults**

- With 1 mm foam, with energy reducer, 2 pieces/aluminium bag.
- Equipped with oxygen tube 200 cm, oxygen mask no. 5 and reservoir bag capacity 1600 ml



**Balon de resuscitare din PVC pentru nou-născuți** 10 1532-2

- De unică folosință, în pungă plastic, 1 set
- Prevăzut cu tub oxigen 200cm, mască oxigen nr.1 și sac rezervor capacitate 280 ml

**Manual Resuscitation made of PVC, for infants**

- Disposable, in plastic bag, 1 set
- Equipped with oxygen tube 200 cm, oxygen mask no. 1 and reservoir bag capacity 280 ml



**Balon de resuscitare din PVC pentru copii** 10 1532-1

- De unică folosință, în pungă plastic, 1 set
- Prevăzut cu tub oxigen 200cm, mască oxigen nr.2 și sac rezervor capacitate 1600 ml

**Manual Resuscitation made of PVC, for children**

- Disposable, in plastic bag, 1 set
- Equipped with oxygen tube 200 cm, oxygen mask no. 2 and reservoir bag capacity 1600 ml



nr. 3 / nr. 3,5 / nr.4 / nr. 4,5 / nr. 5 / nr. 5,5 / nr. 6 / nr. 6,5 / nr. 7 / nr. 7,5 / nr. 8 / nr. 8,5 / nr. 9  
10 buc / pcs

**Sonde pentru intubație endotraheală** 10 2100

- Cu balonaș, sterile
- Tube for endotracheal intubation**
- Sterile, with balloon



extensibil, steril, de unică folosință  
extensible, sterile, disposable

**Cateter Mount** 10 2328

- Utilizat pentru conectarea tubului de traheostomie sau a tubului endotraheal
- Catheter Mount**
- Used to connect the tracheostomy tube or endotracheal tube



**Mască anestezie** 30 2124

- Cu pernă de aer și valvă, manșon gonflabil cu o conexiune de 15-22mm, sterilă

**Anesthesia mask**

- With air cushion and valve, inflatable sleeve with a connection of 15-22 mm, sterile



000 - 40 mm - roz/pink	250
00 - 50 mm, albastru/blue	250
0 - 60 mm, negru/blue	250
1 - 70 mm, alb/white	250
2 - 80 mm, verde/green	200
3 - 90 mm, galben/yellow	200
4 - 100 mm, roșu/red	200
5 - 110 mm, bleu/azure	200
6 - 120 mm, portocaliu/orange	100

**Pipă tip Guedel - polietilenă semirigidă**

• Pipa Guedel poate fi folosită la orice pacient inconștient, rolul ei fiind menținerea liberă a căilor aeriene superioare. Pipa de mărime corespunzătoare și corect introdusă va apăsa baza limbii împiedicând căderea acesteia în spate, spre faringele posterior.

**Guedel type Oral Airway - semi-rigid polyethylene**

• The Guedel airway can be used on any unconscious patient, its role being to maintain open the upper airway. A correctly inserted airway of an appropriate size will press the base of the tongue, this preventing it to fall back towards the posterior wall of the pharynx.

1321

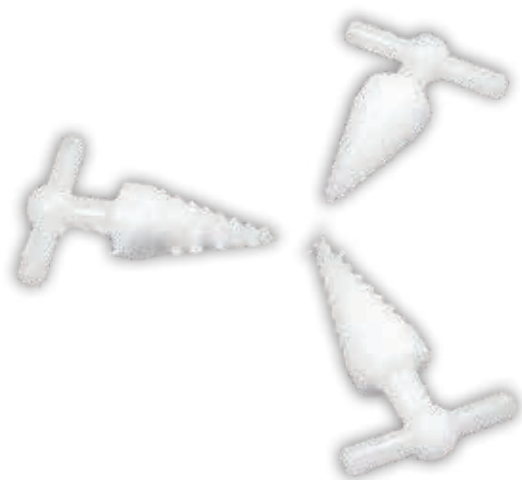

**Deschizător de gură din material plastic spirală**

200 0926

• Se introduce deschizatorul între dinții victimei și prin răsucire se forțează deschiderea gurii

**Emergency mouth opener ( oral screw )**

• Insert the opener between the victim's teeth and by twisting you force the mouth to open



**Dispozitiv respirație gură la gură**

500 0935

• De unică folosință, cu valva din PVC anti-retur și foaie de protecție facială din PVC, netoxică

**First aid mouth to mouth resuscitation mask**

• Disposable, PVC valve; Nonreturn and PVC facial protection sheet, non-toxic.



10 buc / pcs

**Canule nazale pentru administrarea oxigenului**

100 1226

• 2.5 m, fără latex

**Nasal cannula for oxygen supplying, latex free**

• 2.5 m, latex free



tub/tube 20.5 cm pentru copii / for children

tub/tube 22.5 cm pentru adulți / for adults

**Mască Oxigen simplă cu tub Oxygen Mask with tube**

100 1124

G418 Forcepsuri • Forcepses

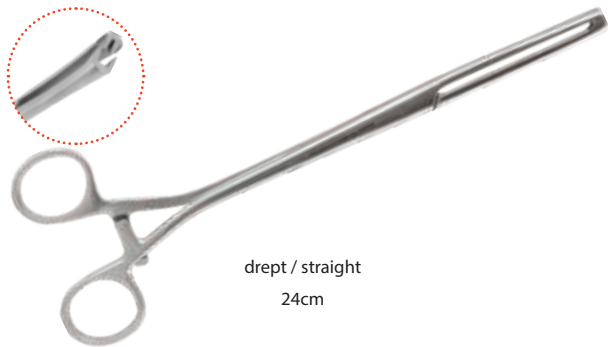

drept / straight  
24cm

**Forceps uterin Museux**

• Din oțel inox

**Museux uterin forceps**

• Made of stainless steel

50 2041-DRT

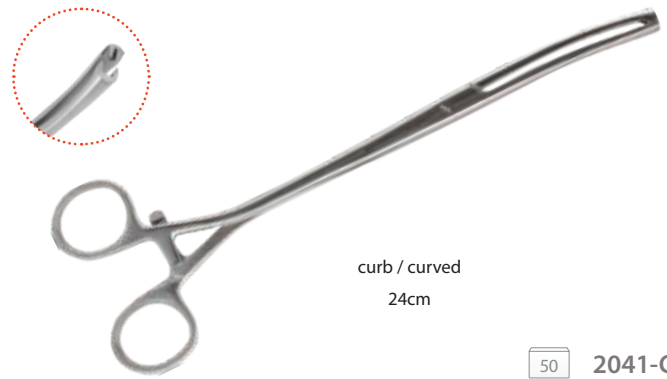

curb / curved  
24cm

50 2041-CRB

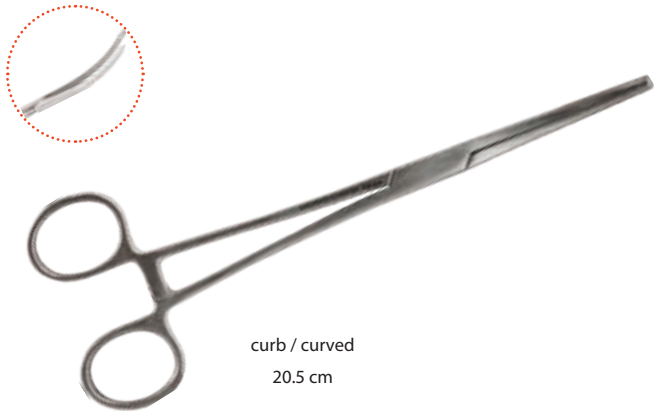

curb / curved  
20.5 cm

**Forceps uterin Jacobs**

• Din oțel inox

**Jacobs uterin forceps**

• Made of stainless steel

50 2040

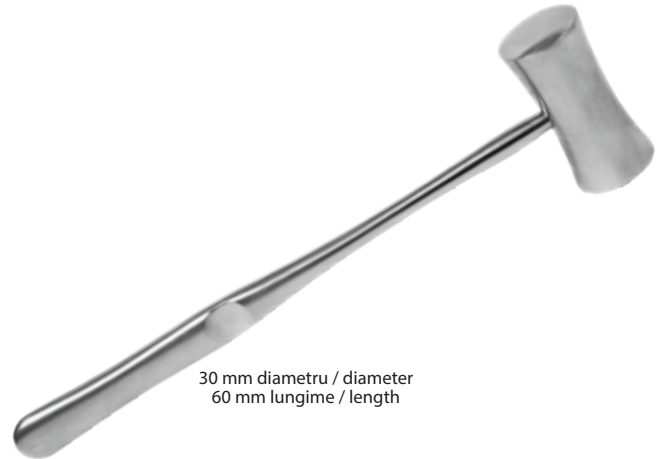

30 mm diametru / diameter  
60 mm lungime / length

**Ciocănel pentru ortopedie**  
**Orthopedic hammer**

10 1540

G420 Laringoscop • Laryngoscope



**Laringoscop MCINTOSH**

• Metalic, cu mâner lungime 16 cm și 5 lame (8, 9, 11.5, 13.5, 15.5 cm)

**MCINTOSH Laryngoscope**

• Metallic, with handle and 5 blades (8,9,11.5, 13.5, 15.5 cm)

10 2038



**Pensă laringiană curbă Magill**  
**Magill curved forceps**

50 2039



20 cm

## G107 Sonde Foley Uretrale • Foley Catheter

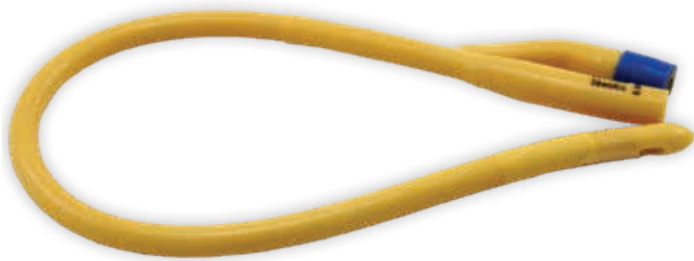

mărimi/size  
CH12, 14, 16, 18, 20, 24  
10 buc/pcs

### Sondă Foley uretrală adulți 2 căi

50 1224

- Se folosesc pentru evacuarea urinei din vezică. Sunt formate din tuburi cu 2 capete, unul ajungând în vezică iar celalalt rămânând în exterior și la care se atașează o pungă colectoare.
- Sterile

### Urinary foley catheter for adults

- They are used to evacuate urine from the bladder. They consist of two-headed tubes, one ending in the bladder and the other remaining outside and attached to a collection bag.
- Sterile



mărimi/size  
CH 06, 08, 10, 12, 14, 16, 18, 20, 24  
100 buc/pcs  
40 cm

### Sondă uretrală Nelaton pentru drenaj, sterile

6 1228

- Cu vârf drept și plin având găuri laterale. Se poate folosi atât la bărbați cât și la femei în timpul / după intervenție chirurgicală sau pentru a determina cantitatea de urină din vezica urinară.
- Sterilă

### Sterile Nelathon urinary catheter for adults

- Straight and full point with side holes. It can be used in both men and women during / after surgery or to determine the amount of urine in the bladder.
- Sterile

## G097 Sonde Alimentație • Feeding Tubes



mărimi / size  
CH4, 5, 6, 8, 10, 12  
100 buc / pcs

### Sondă alimentație gastronală copii

50 1587

- Radioopacă pentru vizibilitate la razele X. Vârf închis cu doi ochi, pentru drenaj ușor. Tub 40 cm, marcat, neporogenic.
- Sterilă

### Feeding tube for children

- Radiopaque for X-Ray visibility. 40 cm length, 2 lateral eyes for drainage smooth coned shaped for easy insertion in abdominal.
- Sterile



mărimi / size  
CH4, 6, 8, 10, 12  
100 buc / pcs

### Sondă alimentație gastronală adulți

50 1248

- Radioopacă pentru vizibilitate la raze X
- Vârf închis cu 2 ochi, pentru drenaj ușor, tub 50 cm marcat, nepirogenic, netoxic.
- Sterilă

### Feeding Tube, radiopaque for X-Ray visibility, for adults

- Closed top with 2 eyes, for easier drainage, 50 cm marked tube, non-pyrogenic, non-toxic.
- Sterile

## G250 Sonde Nazo-Gastrice Levin • Levin Nasi-Gastric Tubes



mărimi / size  
CH6, 8, 10, 12, 14, 16  
50 buc / pcs  
120 cm

mărimi / size  
CH18, 20, 22  
30 buc / pcs  
120 cm

### Sondă nazo-gastrică Levin

10 1339

- Pentru administrarea medicamentelor și a alimentelor, vizibilitatea la Raze-X de-a lungul corpului, atraumatice, corp din PVC
- Sterilă

### Levin naso-gastric tubes

- For drug and food administration, X-Ray visibility throughout the body, atraumatic PVC body.
- Sterile

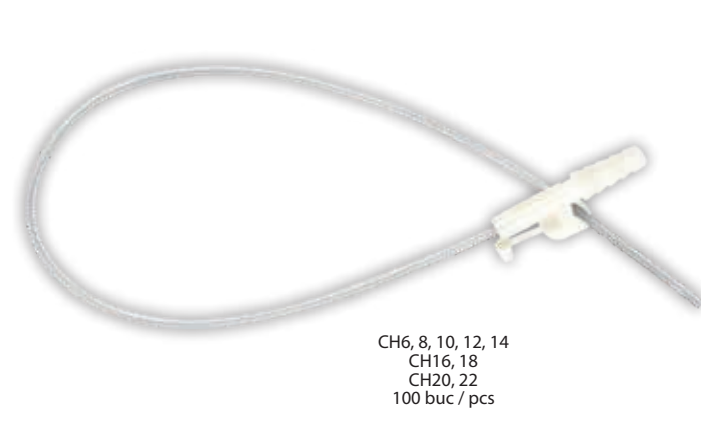

CH6, 8, 10, 12, 14  
CH16, 18  
CH20, 22  
100 buc / pcs

### Sondă aspirație cu valvă

200 1344

- Radioopacă pentru vizibilitate la razele X, vârf deschis cu doi ochi mari laterali, tub 50 cm marcat, nepirogenic, netoxic.
- Sterilă

### Aspiration catheter with valve

- Radiopaque for x-ray visibility, open top with 2 large laterla eyes, 50 cm tube, non-pyrogenic, non-toxic.
- Sterile



10 buc / pcs

- M  10
- L  10
- XL  10

**Scutece incontinență, adulți** 0903  
**Adult diaper, anti-bacterial absorbant polymer layers**



- 40 x 60 cm ( 30 buc / pcs )  10
- 60 x 60 cm ( 30 buc / pcs )  6
- 60 x 90 cm ( 30 buc / pcs )  6
- 90 x 180 cm ( 15 buc / pcs )  4

**Cearceafuri incontinență** 0904  
**Incontinence fluff under pads**

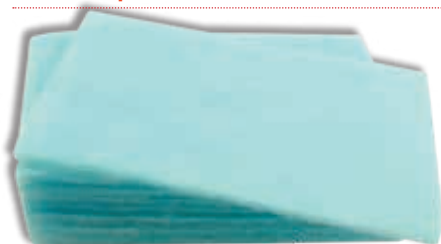

12x20 cm, pH: 5.5  
 10 buc / pcs

**Bureți de fibra de poliester**  20 1333-11  
 • Impregnați cu gel de duș (1.1 gr), de unică folosință  
**Poliester Bath Sponges**  
 • Impregnated with shower gel (1.1 gr), for single use only



sizes / mărimi  
 S(Ø25mm), M(Ø30), L(Ø35), XL(Ø40mm)

**Condom urinar pentru incontinență**  50 2180  
 • Pentru bărbați  
**Condom for urinary incontinence**  
 • For men



20 buc/pcs

**Punga igienică pentru vasul de toaletă**  18 1791  
 • Cu pad absorbant.  
**Toilet bowl hygienic**  
 • Absorbent pad.



64 buc / pcs

**Șervețele umede incontinență, adulți**  24 2049  
**Wet wipes for adult incontinence**



capacitate / capacity 500 ml,  
 lungime tub / tube length 150 cm,  
 sterile / sterile  
 25 buc / pcs

capacitate / capacity 750 ml,  
 lungime tub / tube length 35 cm,  
 nesterile / non-sterile  
 30 buc / pcs

**Pungi urinare cu prindere pe picior**  10 2098  
**Urinary leg bags**



20 buc / pcs

**Pungă igienică pentru bărbați**  21 1790  
 • Cu pad absorbant ce transformă urina în gel.  
**Male urinal bag**  
 • With super absorbent pad, turns urine into gel and locks bad odors.



100 buc / pcs

**Pungă urinară copii, 100 ml**  40 0391  
 • Sterilă  
**Pediatric urine drainage bag, 100 ml**  
 • Sterile



10 buc / pcs

**Pungă urinară adulți, 2000 ml, cu Evacuare T**  40 0378  
 • Sterilă  
**Common urine drainage bag with cross valve, 2000 ml**  
 • Sterile



1.7 litri / liters  
**Ploscă din carton, de unică folosință**  
**Disposable cardboard medical flask for bedridden patients**

120 1473



1 litri / liters  
**Urinar din carton, de unică folosință**  
**Disposable cardboard urinary container for men**

150 1474-MAN



0.75 litri / liters  
**Urinar femei**  
 • Sterilizabil  
**Urinary container for women**  
 • Sterilizabile

60 1328-WOM



1 litru / liter  
**Urinar bărbați**  
 • Sterilizabil  
**Urinary container for men**  
 • Sterilizabile

60 1328-MAN



**Suport urinar pentru ploscă din carton**  
 • Autoclavabil  
**Support for cardboard medical flask**  
 • Autoclavable

120 1518



2 litri / liters  
**Ploscă Medicală pentru pacienții imobilizați la pat**  
 • Sterilizabilă  
**Medical Flask for bedridden patients**  
 • Sterilizabile

20 1327



2 litri / liters  
 inox / stainless steel

**Ploscă medicală**  
 • Pentru pacienți imobilizați  
**Medical bedpan**  
 • For bedridden patients

4 1526



0.75 litri / liters  
 inox / stainless steel

**Urinar femei**  
**Urinary container for women**

4 1539



1 litru / liter  
 inox / stainless steel

**Urinar bărbați**  
**Urinary container for men**

4 1534





**Scaun toaletă pliabil** 20 1583  
 • Cu recipient WC  
**Foldable toilet commode with WC**  
 • With WC



**Scaun de baie cu spătar** 20 1581  
 • Dreptunghiular  
**Bath seat with backrest**  
 • Rectangular



greutate maximă admisă / maximum allowed weight: 100 kg

**Cărucior cu roțile pliabil** 20 1582-100  
 • Antrenare manuală  
**Transporting patients foldable wheelchair**  
 • Manual training



**Cadru de mișcare pliabil** 20 1580  
 • Din aluminiu cu mișcare pas cu pas.  
**Folding walking frame**  
 • Aluminium with step by step motion.



**Cârjă cu sprijin pe cot** 20 1579  
**Crutch with elbow support**

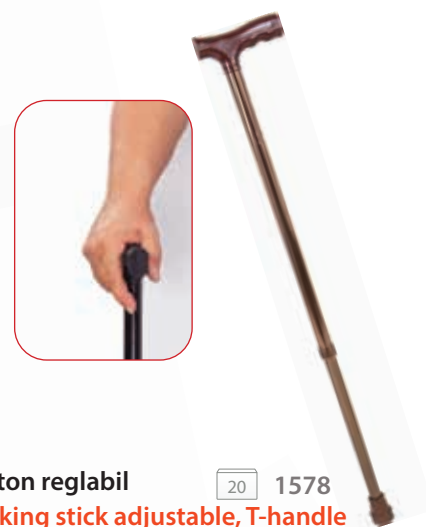

**Baston reglabil** 20 1578  
**Walking stick adjustable, T-handle**



mărimi / sizes  
 185x50x18cm, 188 x 53 x 21 cm  
 marcaj CE / CE mark

**Targă pliabilă cu 2 roți** 5 1506  
**Folding stretcher with 2 wheels**



42 cm, 100 buc/pcs  
46 cm, 100 buc/pcs  
albastru/blue  
alb/white

**Bonetă unică folosință cu elastic și clip**

• Pentru protecția părului, unică folosință

**Non-woven clip cap, single elastic**

• For hair protection, disposable

20 0279



33 x 17 x 7 cm  
100 buc/pcs

**Bonetă doctor cu legături**

• Este folosită pentru protecție de cadrele medicale.

**Non-woven doctor cap with ties**

• Is used for protection by medical staff.

10 0281



100 buc/pcs  
albastru/blue

**Bonetă bufantă elastic**

• Pentru protecția părului

**Non-woven bouffant cap**

• For hair protection

10 1235-48-COZ



100 buc/pcs  
albastru/blue

**Boneta tip cagula cu legaturi**

• Este folosită pentru protecție de cadrele medicale.

**Cagula bonnet with binding**

• Is used for protection by medical staff.

1 1820



3 pliuri și 3 straturi cu elastic  
3 ply and 3 layers with ear-loop

**Mască medicală**  
**Surgical face masks**

20 0283



50 buc/pcs  
18 x 15 cm

legături/ties on both sides



PPSB  
XXL  
white / blue  
75 x 120 cm  
1 buc / pcs



PPSB  
XXL  
white / blue  
75 x 120 cm  
10 buc / pcs

**Halat protecție tip laborator, fără buzunare**  
**PPSB protection lab coat, no pockets**

100 0286

**Halat protecție tip vizitator**  
**PPSB protection gown, visitor type**

10 0285



bandă elastică în talie  
elastic waist band

L, XL  
alb / white

**Pantaloni protecție SFI**  
**SFI protective pants**

100 2025



manșetă din bumbac elastică  
cotton elastic cuff

XXL  
alb / white

**Halat protecție tip laborator SMMS**  
**SMMS lab coat with zipper and cotton cuffs**

100 1306



alb / white  
3 XL

- Cu glugă, fermoar în față, elastic la glugă, mâini, mâini, talie și picioare, PPSB
- With hood, with zipper on front, elastic on hood, hands, waist and feet, PPSB

**Combinezon cu glugă**  
**Coverall with hood**

50 0287



58 cm x 150 m

68 cm x 150 m

395 foi / sheets x 38cm

**Cearceaf pat**

• Rolă TNT textil nețesute

**Bed cover**

• Nonwoven

6 0152



10 buc / pcs  
50 x 70 cm

**Față de pernă PPSB**  
**PPSB Cushion Covers**

20 0992

10 buc / pcs  
90 x 225 cm

**Cearceaf pat PPSB cu elastic la colțuri**  
**PPSB Bed cover with elastic corners**

10 0150

10 buc / pcs  
90 x 225 cm

**Cearceaf pat impermeabil PPSB laminat**  
**PPSB laminated bed cover with elastic corners**

10 0150-10-PE



80 x 180 cm  
160 x 220 cm  
10 buc / pcs

**Cearceaf pat PPSB fără elastic**  
**PPSB bed cover without elastic**

10 1441



**Dispenser rolă cearceaf, metalic**  
**Stainless steel dispenser for medical paper rolls**

9 0593



50 cm x 46 m

12

50 cm x 100 m

6

**Cearceaf hârtie premium**  
**Medical bed sheet**

0532



60 cm x 46 m

6

60 cm x 100 m

6

**Cearceaf hârtie premium**  
**Medical bed sheet**

0533



50 cm x 70 m / 58 cm x 70 m / 68 cm x 70 m  
alb/white, albastru/blue  
1 buc / pc

**Cearceaf rolă TNT nețesut**

• Pretăiat la 38 cm, 15 g

**Nonwoven bed cover**

• Perforat la 38 cm, 15 g

10 2176



50 cm x 70 m  
alb/white

**Cearceaf rolă TNT nețesut**

• Pretăiat la 140 cm, 20 g

**Nonwoven bed cover**

• Perforat la 140 cm, 20 g

10 2177



50 cm x 70 m  
roz, portocaliu, mov, negru/pink, orange, purple, black

**Cearceaf rolă TNT nețesut**

• Pretăiat la 38 cm, 20 g

**Nonwoven bed cover**

• Perforat la 38 cm, 20 g

10 2178



50 cm x 50 m  
alb/white

**Cearceaf rolă TNT nețesut**

• Pretăiat la 38 cm, 40 g

**Nonwoven bed cover**

• Perforat la 38 cm, 40 g

10 2179

G185 Mușama Pat Cauciuc • Rubber Bed Cover



**Mușama cauciuc**  
**Rubber bed cover**

1191



90 x 100 cm 100

90 x 200 cm 50

0.90 x 10 m  
(rolă / roll) 6



50 cm x 50 m  
alb / white  
albastru / blue

60 cm x 50 m  
alb / white  
albastru / blue

PE, 130 de foi x 38.5 cm

2 straturi laminate  
2 ply tissues, laminated



Cearceaf polietilenă, hârtie + PE  
Medical bet sheet, paper + PE

6 1411

G166 Papuci Unică Folosință • Disposable Slippers



deschis  
open



închis  
close

50 perechi / pairs

**Papuci PPSB, unică folosință** 5 0149

- În cabinete medicale, în clinici, laboratoare analiză
- Dimensiuni: 10.5 x 28 cm - mărime unică

**PPSB slippers - single use**

- In medical offices, clinics, labs
- Dimensions: 10.5 x 28 cm - unique size

deschis  
open



închis  
close

10 perechi / pairs

**Papuci frotir cu talpă EVA** 100 0387

- Comozo și puternic absorbant datorită texturii de frotir
- Închis / deschis

**Terry cotton slippers**

- Comfortable and highly absorbent due to the terry texture
- Close / Open



**Papuci talpă Eva, față PPSB** 10 1407

- Închiși la degete, 1 pereche

**Slippers with Eva sole + PPSB**

- Close toe, 1 pair



25 perechi / pairs

**Papuci polistiren expandat, interdeget**  
**Extruded polystyrene slippers, inter-toe**

10 0967



colorați / colored  
12 perechi / pairs  
10.5 x 28 cm



**Papuci EVA, interdeget**

30 0719

- Se construiesc de utilizator: se ridică separatorul interdeget și baretă de la călcâi. Se prinde separatorul de baretă.

**EVA slippers, inter-toe**

- Built by the user: lift the separator and the heel strap. Attach the separator to the strap.



- 10 litri/liters  25
- 20 litri/liters  20
- 40 litri/liters  20

**Cutii deșeuri infecțioase**

0255

• Pentru depozitarea deșeurilor infecțioase neîntepătoare (vată, ceară de epilat folosită fașe și maști de unică folosință) - inscripționate "pericol"

**Cremation boxes for medical waster**

• For storing not stinging infectious wastes (wool, used wax, bandage, disposable masks) - Labeled "biohazard"



- 10 litri / liters
- 20 litri / liters
- 40 litri / liters
- 120 litri / liters

25 buc / set

**Saci deșeuri infecțioase**

100 0638

• Pentru depozitarea deșeurilor infecțioase neîntepătoare (vată, ceară de epilat folosită fașe și maști de unică folosință)

**Yellow bag with "Biological Hazard" sign**

• For storing not stinging infectious wastes (wool, used wax, bandage, disposable masks)

G126, G127 Recipienti Deșeuri Tăietoare Întepătoare • Cremation Recipients for Medical Waste

**i** Recipiente din material plastic rigid (polipropilenă) cu posibilitate de închidere temporară și definitivă.  
 - cu o rezistență mecanică ridicată  
 - capacul recipientelor prezintă orificii speciale pentru detașarea acelor de seringă, a lamelor de bisturiu, etc., precum și a altor deșeuri întepătoare-tăietoare de dimensiuni mai mari. Sistemul de închidere definitivă reduce posibilitatea de contaminare a personalului care manipulează deșeurile întepătoare-tăietoare, cât și refolosirea de către persoane din exteriorul unităților sanitare.  
 - odată închis definitiv, recipientul este distrus prin incinerare. În urma acestui proces nu rezultă deșeuri toxice.  
 Rigid plastic containers (polypropylene) with the possibility of temporary and permanently closure.  
 - with high mechanical resistance  
 - containers lids have slits for detaching needles, blades of scalpel, etc. and other large dimension sharp-cutting waste. The permanent closure reduces the possibility of contamination of personnel who handle waste prickly-cutters, and reuse by people outside the medical units.  
 - once closed down, the container is destroyed by incineration. Following this process, the resulted waste is not toxic.

**i** Certificate ADR / ADR certificate



- 1 litru/liter  154
- 3 litri/liters  80
- 5 litri/liters  45
- 7 litri/liters  29
- 12 litri/liters  20

**Recipient plastic deșeuri întepătoare tăioase**  
**Plastic container for sharp stinging waste**

0162



**20 L**  
500x700x0.05mm, 33 gr  
certificat ADR / ADR certificate

50



**40 L**  
600x900x0.05mm, 50 gr  
certificat ADR / ADR certificate

50



**120 L**  
900x1100x0.05mm, 85 gr  
certificat ADR / ADR certificate

50



**300 L**  
1200x1450x0.05mm, 158 gr  
certificat ADR / ADR certificate

50

**Sac galben "BIOHAZARD"**

• 50 microni

**Yellow bag with "BIOHAZARD" sign**

• 50 microns

1992



30 x 60 cm, 27 litri

25

40 x 75 cm, 45 litri

20

60 x 75 cm, 68 litri

25

75 x 90 cm, 100 litri

20

**Saci autoclavabili pentru deșeuri medicale**

• Sac transparent autoclavabil cu semn Biohazard, rezistent la 134 °C

**Garbage bags for medical waste**

• Transparent autoclavable bag with Biohazard sign, resistant at 134 °C

1412



**Pungă polipropilenă**

• Pentru transportul lichidelor citologice, a probelor histologice  
• Închidere cu fermoar și buzunar pentru documente

**Polypropylene bag**

• For cytological and hystological samples transport  
• With zip-lock and pocket for documents

1957



14.5 x 23 cm  
100 buc / pcs



16 x 16.5 cm  
100 buc / pcs



## G150 Exudat Faringian • Sterile Swabs

plastic + bumbac/plastic + cotton

lemn + bumbac/ wood + cotton



### Exudat faringian

- Plastic/lemn + bumbac, în tub 12 x 150 mm, ambalat individual
- Sterile

100 buc/pcs

100

0151

#### Swab

- Plastic/wood applicator and cotton tipped, in tube 12 x 150mm, individually packed.
- Sterile

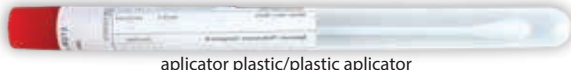

aplicator plastic/plastic applicator



aplicator lemn/wodden applicator

100 buc/pcs



Amies

Stuart

100 buc/pcs

### Exudat faringian

- Plastic/lemn + bumbac, în tub 12 x 150 mm, cu etichetă
- Sterile

20

0245

#### Swab

- Plastic/wood applicator with cotton tip, in tube 12 x 150mm, w/label
- Sterile

### Exudat faringian cu mediu de transport

- 12 x 150 mm, cu etichetă

10

0295

#### Swab with transport medium

- In tube with label

## G092 Spatule Lemn • Tongue Depressors



200 buc/pcs  
114 x 10 x 2 mm

100 buc/pcs  
150 x 18 x 1.6 mm



100 buc/pcs  
150 x 18 x 1.6 mm

### Spatule lemn

- Utilizate în clinici și cabinete medicale în examinarea cavității bucale și a orofaringelui.
- Sterile

50

0250

#### Individually packed wooden tongue depressor

- Used in medical clinics for examination of the mouth and oropharynx.
- Sterile

### Spatule lemn nesterile

#### Wooden tongue depressor loose pack, not-sterile

50

0249

### Lanternă tip stilou

- Aluminiu, lumină galbenă

#### Pen Light

- Aluminiu, yellow light



50

1924



14 cm

## G152 Lame & Lamele de Microscop • Microscope Slides & Covers



colțuri tăiate/cut edges

colțuri finisate/ground edges

50 buc/pcs  
26 x 76 x 1.2 mm

### Lame microscop colțuri tăiate sau finisate

- Fragment din sticlă subțire pe care se aplică preparatul microscopic.

#### Microscope slides, single frosted, cut edges

- Thin glass on which apply the microscopic preparation.

50

1012



10 cutii x 100 buc/set  
10 boxes x 100 pcs/set

18 x 18 mm

40

20 x 20 mm

40

22 x 22 mm

40

24 x 24 mm

40

24 x 50 mm

40

24 x 60 mm

40

### Lamele acoperire microscop

#### Coverglass, in hinge plastic boxes

1013

G154 Cutii Petri • Petri Dishes



10 buc / pcs  
90 x 15 mm  
EO Sterile  
1 compartiment

Cutii Petri

50 0598

• Își păstrează forma până la 55 grade Celsius. Greutate optimă. Cu fundul plat. Capac cu ventilație prin 3 orificii. De unică folosință.

Cardboard kidney tray, single use

• It maintains its shape up to 55 degrees Celsius. Optimal weight. Flat-bottomed. Made of polystyrene. With cover ventilated on 3 sides.

G405 Anatomie Patologică • Anatomical Pathology

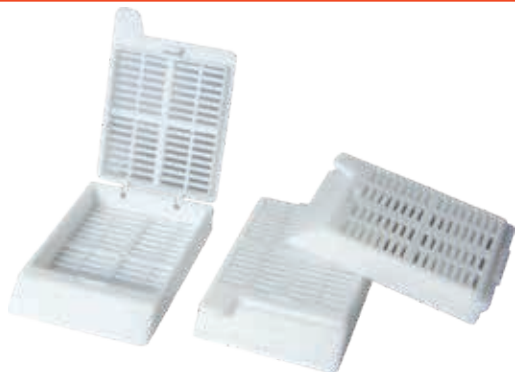

500 buc

Casete histologice tip grătar

10 1949

• Pentru includere parafină

Hystological cassettes grate

• For paraffine inclusion



pungă / bag  
2kg

Parafină histologică cu polimeri 56°C-58°C

10 1950

• Pentru preparatele histologice

Histology paraffin with polymers 56°C-58°C

• For paraffine inclusion

G153 Recipienti Recoltare Medicală • Recipients for Medical Samples



steril/sterile  
120 ml

100

steril/sterile  
60 ml

500

Recipient urocultur ambalat individual  
Urine container, individually packed

0725



steril/sterile  
20 ml

100

steril/sterile  
60 ml

500

Recipient coprocultură cu spatulă recoltare  
Fecal collection containers

0726



10 ml  
100 buc/pcs  
16 x 100 mm

Eprubete cilindrice, capăt conic  
Cylindrical test tube with conic end

8 1254



2 ml  
50 buc/pcs

Criotuburi

10 1610

• Gradate din 0.25 până la 1.25 ml, din polipropilenă, sterilizate cu radiații gamma, autoclavabile

Cryotubes

• Graded from 0.25 until 1.25 ml, polypropylene, sterilized with gamma radiations, autoclavable



100 buc/pcs  
roșu/red

Dopuri pentru eprubetă  
Caps for sample tubes

100 1067-DOP



10 ml  
100 buc/pcs  
16 x 100 mm

Eprubetă sumar urină cu fund rotund  
Urine sample tube with round bottom

24 1067-EPR

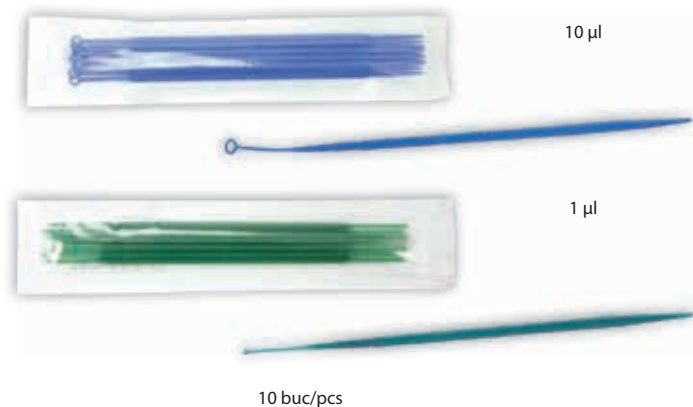

**Anse sterile**

• Sterile

**Sterile inoculation loop**

• Sterile

600 0800



0,5-10 µl  
2-20 µl  
5-50 µl  
10-100 µl  
20-200µl  
100-1000µl  
500-5000µl

**Pipetă automată monocanal**

• Componente autoclavabile, cu volum reglabil

**Single channel automatic pipette single channel**

• Autoclavable components, variable volume

10 1516



100 buc/pcs 3 ml

**Pipetă Pasteur 3 ml, ambalată individual**

• Sterile

**Pasteur pipette 3 ml, individually packed**

• Sterile

40 1070



5-50 µl  
20-100 µl  
30-300 µl

**Pipetă automată opt canale**

• Componente autoclavabile, cu volum reglabil

**Automatic pipette eight channels**

• Autoclavable components, variable volume

10 1641



0 - 200 µl  
1000 buc / pcs

200 - 1000 µl  
500 buc / pcs

200 - 1000 µl  
1000 buc / pcs

50

15

**Vârfuri autopipeta, tip Eppendorf-Brand-Socorex**

1068

**Tips for automatic pipette, type Eppendorf-Brand-Socorex**



1.5 ml  
1000 buc / pcs

**Micro tub de test conic cu capac, tip Eppendorf**

10 1069

**Conic micro test tube with cap, Eppendorf type**



2 ml  
500 buc/pcs

**Criotuburi**

• Gradate din 0.5 până la 1.8 ml, din polipropilenă, nesterile

**Cryotubes**

• Graded from 0.5 until 1.8 ml, polypropylene, non-sterile

10 2092



gradate 1 ml

**Pipete serologice**

• Gradate, polistiren ultra-transparent, filtru din bumbac

**Serological pipette**

• Graded, ultra-transparent polystyrene, cotton filter

10 2095

**Vacutainer hematologie**  
Hematology vacuum blood collection tube

12 1073



- Tubul conține anticoagulant K3 EDTA (soluție lichidă ce se găsește în interiorul tubului). Tuburi EDTA sunt preferate de majoritatea laboratoarelor de genetică moleculară pentru studii genetice moleculare (ADN sau ARN). Vacuum: 3ml.
- Produs steril, de unică folosință.

- Tube contains K3 EDTA anticoagulant (liquid solution in the glass tube). EDTA tubes are preferred by most molecular genetics laboratories for molecular genetic studies (DNA or RNA). Vacuum: 3ml.
- Sterile product, for single use only.

Cod Code	Vol (ml)	Mărime (mm) Size (mm)	Aditivi Additives	Cantitate Quantity
1071-3ML	3 ml	13x75mm	Anticoagulant K3 EDTA	100 buc/pcs

**Vacutainer biochimie cu activator de coagulare**  
Hematology vacuum blood collection tube

12 1072



- Tubul conține activator de coagulare și se folosesc pentru determinări de biochimie și imunologie. Timp accelerat de coagulare. Vacuum: 6ml.
- Produs steril, de unică folosință.

- Tube contains clot activator and is used in determinations for clinical biochemistry, immunology. Fast in coagulation. Vacuum: 6ml.
- Sterile product, for single use only.

Cod Code	Vol (ml)	Mărime (mm) Size (mm)	Aditivi Additives	Cantitate Quantity
1072-6ML	6 ml	13x100mm	Activator coagulare Clot activator	100 buc/pcs
1072-9ML	9 ml	13x100mm	Activator coagulare Clot activator	100buc/pcs

**Vacutainer biochimie**  
Biochemistry vacuum blood collection tube

12 1748



- Vacutainer Biochimie capac galben cu gel separator 5ml steril, din plastic, cu capac de protective galben, conform codului international de culoare. E utilizat pentru colectarea probelor in cadrul laboratoarelor de biochimie si imunologie, volumul de aspiratie fiind 5ml.
- Produs steril, de unică folosință.

- Vacutainer Biochemistry, with sterile separating gel 5ml, plastic and yellow protective cap, according to the international color code. It is used for collecting samples in biochemistry and immunology laboratories. The separating gel is intended to obtain and separate serum from blood samples.

- Sterile product, for single use only.

Cod Code	Vol (ml)	Mărime (mm) Size (mm)	Aditivi Additives	Cantitate Quantity
1748-5ML	5 ml	13x100mm	Activator coagulare și gel separator Clot activator and polymer gel	100 buc/pcs

**Vacutainer biochimie**  
Vacuum Blood Collection Tube biochemistry

12 1960-6ML



- Volum aspirație 6ml
- Steril
- Draw volume 6ml
- Sterile

Cod Code	Vol (ml)	Mărime (mm) Size (mm)	Aditivi Additives	Cantitate Quantity
1960-6ML	6 ml	13x100mm	Fără aditiv Without additives	100 buc/pcs

**Vacutainer VSH**  
Vacuum blood collection tube VSH

12 1071



- Vacutainer VSH, capac negru, contine anticoagulant Na Citrat 3,8% si se foloseste pentru a obtine o proba de sange pentru determinarea VSH-ului. Testul nu diagnosticheaza o anumita afectiune inasa ajuta medicul si ii arata de ce alte teste ati avea nevoie pentru a putea determina cauza simptomelor. Este, de asemenea, o modalitate de a vedea cat de bine functioneaza tratamentul pentru o anumita boala. Vacuum:1.6ml.

- Produs steril, de unica folosinta.
- Blood collection tube, black protective cap, contains 3.8% buffered sodium citrate and are used to obtain a whole blood sample for ESR determination. This test doesn't diagnose one specific condition but it can help your healthcare provider know what other tests you might need to determine the cause of your symptoms. It's also a way to see how well treatment for a disease is working. Vacuum:1.6ml.

- Sterile product, for single use only.

Cod Code	Vol (ml)	Mărime (mm) Size (mm)	Aditivi Additives	Cantitate Quantity
1071-1375	1.6 ml	13x75mm	Anticoagulant Na Citrat 3.8%	100 buc/pcs
1071-8120	1.6 ml	8x120mm	Anticoagulant Na Citrate 3.8%	100 buc/pcs

**Vacutainer pentru glicemie**  
Vacuum blood collection tube

12 1961



- Vacutainer pentru glicemie, capac gri, cu oxalat de fluor
- Steril
- Blood collection tube, grey cap, with fluoride oxalate
- Sterile

Cod Code	Vol (ml)	Mărime (mm) Size (mm)	Aditivi Additives	Cantitate Quantity
1961-2ML	2ml	13x100mm	Oxalat de fluor / Fluoride oxalate	100 buc/pcs

**Vacutainer coagulare, 3.8% Na Citrate**  
3.8% Na Citrate vacuum blood collection tube for coagulation

10 1430



- Conține anticoagulant citrat de sodiu 3.8%. Testele de coagulare măsoară cât de bine și cât de repede / lent coagulează sângele unei persoane.
- Produs steril, de unica folosinta.
- Contains sodium citrate 3.8%. Coagulation tests measure how well and how fast a person's blood coagulates.
- Sterile product, for single use only.

Cod Code	Vol (ml)	Mărime (mm) Size (mm)	Aditivi Additives	Cantitate Quantity
1430-2ML	2 ml	13x75mm	Anticoagulant Na Citrat 3.8%	100 buc/pcs
1430-4.5ML	2 ml	13x75mm	Anticoagulant Na Citrate 3.8%	100 buc/pcs

**Vacutainer cu Lithiu Heparină**  
Lithium Heparin micro test tube

12 1424



- Tubul din sticla este folosit pentru determinari in plasma in cadrul departamentelor de chimie clinica. Concentratia de Litiu si Sodiu Heparina este de 17 UI/ml de sange
- Steril
- Glass tube is used for plasma determinations in clinical chemistry, plasma tube is 17 International Units of Heparin/ml of blood.
- Sterile

Cod Code	Vol (ml)	Mărime (mm) Size (mm)	Aditivi Additives	Cantitate Quantity
1424-6ML	6 ml	13x100mm	Lithiu heparina Lithium Heparin	100 buc/pcs

## G157 Tuburi Vidate pentru Colectarea Sângelui • Vacuum blood Collection Tubes

### Microcontainer cu Lithiu Heparină

12 1424

#### Lithium Heparin micro test tube



- Steril
- Sterile

Cod Code	Vol (ml)	Aditivi Additives	Cantitate Quantity
1424-0.5ML	0.5 ml	Lithiu heparina Lithium Heparin	50 buc/pcs

### Microtainer biochimie Hematology vacuum blood collection tube

12 1072



- Steril
- Sterile

Cod Code	Vol (ml)	Aditivi Additives	Cantitate Quantity
1072-0.5ML	0.5 ml	Activator coagulare Clot activator	50 buc/pcs

### Microtainer hematologie Hematology vacuum blood collection tube

12 1073



- Steril
- Sterile

Cod Code	Vol (ml)	Aditivi Additives	Cantitate Quantity
1073-0.5ML	0.5 ml	Anticoagulant K3 EDTA	50 buc/pcs

## G156 Ace Vacutainer • Vacuum Blood Collection Needles



18G x 1½"(1.2 x 38 mm)  
roz/pink  
100 buc/pcs



21G x 1½"(0.8 x 38 mm)  
verde/green  
100 buc/pcs



22G x 1½"(0.7 x 38 mm)  
negru/black  
100 buc/pcs

### Ace vacutainer de prelevare sânge

- Sterile

#### Blood collection needles

- Sterile

50 1074

## G417 Consumabile Afecțiuni Oculare • Single Use Products for Ophthalmology

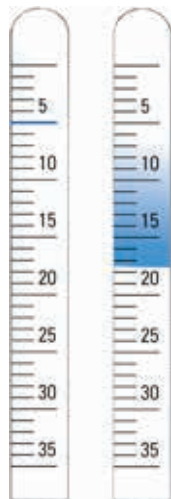

100 buc / pcs



100 buc / pcs

### Test Schirmer

- Benzi oftalmice Schirmer pentru măsurarea producției lacrimale, folii gradate în ambalaj steril individual.

- Sterile

#### Schirmer Strips

- Diagnostic strip that measures the amount of tear production, graduated sheets in individual sterile packaging.

- Sterile

10 1625

### Test Fluoresceina

- Benzi oftalmice îmbibate în soluție de fluoresceină pentru vizualizarea defectelor sau aberațiilor epiteliului corneean.

- Sterile

#### Fluorescein Test

- Diagnostics strip to visualize defects or abrasions in the corneal epithelium by staining the areas of cellular loss.

- Sterile

10 1626



fecale / fecal

**Test Adenovirus antigen**  
**Adenovirus Ag test**

10 1605



ser / plasma

**Test anticorpi**  
**Helicobacter pylori**  
**Helicobacter pylori Ab**

10 1606



**Test hemoragii oculte**  
**din materiile fecale**  
**Fecal occult blood test**

10 1607



ser / plasma

**Test Sifilis**  
**Anti - Syphilis test**

10 1608



**Test menopauză**  
**Menopause test**

10 1594



probă din materiile fecale  
stool samples

**Test rapid AG rotavirus**  
**Rapid test for Ag rotavirus**

10 1570



test pentru HIV  
casetă ser / plasmă  
cassette serum/plasma

**Test rapid HIV 1+2**  
**HIV 1+2 rapid test**

50 1097



antigen de suprafață al hepatitei B  
casetă ser / plasmă  
cassette serum/plasma

**Test rapid HBsAg**  
**HBsAg rapid test**

50 1099



test pentru hepatită C  
casetă ser / plasmă  
cassette serum/plasma

**Test rapid HCV**  
**HCV rapid test**

50 1098



casetă ser/plasmă  
cassette serum/plasma

**Test rapid Trichomonas**  
**Vaginalis**  
**Rapid test for Trichomonas Vaginalis**

10 1571



10 parametri  
10 reagents



pentru ulcerul duodenal, casetă ser / plasmă  
for duodenal ulcers, cassette serum / plasma

**Test rapid Helicobacter Pylori**  
**Helicobacter Pylori rapid test**

25 1096



casetă ser/plasmă  
cassette serum/plasma

**Test Giardia Lamblia**  
**Giardia Lamblia rapid test**

10 1573



casetă ser/plasmă  
cassette serum/plasma

**Test rapid Candida Albicans**  
**Rapid test for Candida Albicans**

10 1572

**Teste de urină**  
**Urine test strips**

10 1533



1000 ml

6



200 ml

25



85 ml

20

**Apă oxigenată 3%**

1436

• Este un dezinfectant sigur, netoxic și eficient, omorând microbii fără a ne periclita sănătatea. Compus doar din apă și oxigen, peroxidul de hidrogen este un bun antiseptic. Distrugem germenii oxidându-i, fiind cel mai de temut dușman al paraziților, virușilor și toxinelor.

**Hydrogen peroxide 3%**

• It's a safe and efficient disinfectant, non-toxic, removing microbes without affecting our health. Composed only of water and oxygen, it's a good antiseptic. Destroying germs by oxidation, it's the most feared enemy for parasites, viruses and toxins.



0.1%  
200ml

**Soluție Rivanol**

60

0907

**Rivanol solution**



1%  
200 ml

**Soluție alcool iodat**

60

0908

**Iodine alcohol solution**



500 ml

12



200 ml

12

**Spirt medicinal, alcool 70%**

0869

• Soluție dezinfectantă, recomandată pentru masaje și igienizări  
• Pentru uz extern

**Alcohol 70%, for medical use**

• Disinfecting solution recommended for massages and sanitation  
• For external use



25 g

antiseptic, dezinfectant și analgezic  
antiseptic, disinfectant and analgesic

**Alabastru de metilen**

10

1702

**Methylen blue**



25 g

antiseptic, dezinfectant și analgezic  
antiseptic, disinfectant and analgesic

**Violet de gențiană 1%**

25

1703

**Gentian violet 1%**



10 tablete/tablets

**Perogen**

20

0944

• Prin eliberarea oxigenului în stare născândă, produsul are acțiune antiseptică, de scurtă durată  
• Spălarea plăgilor supurate, a plăgilor chirurgicale, gynecologice, otite, etc.

**Perogen(urea peroxide)**

• By releasing nascent oxygen, the product acts as an antiseptic of short duration  
• Used for the washing of suppurated wounds, surgical wounds, gynecological wounds, ear infections, etc.



50 gr  
100% bumbac / cotton

**Vată hidrofilă  
Medical cotton pleat**

120

0939



50 g

60

100 g

40

100 g

20

**Vată hidrofilă tip BC - 50% bumbac, 50% celuloză  
Medical cotton pleat - 50% cotton, 50% cellulose**

0254



19 mm x 50 m  
autoadeziv/adhesive  
rolă bandă/root band

**Indicator chimic pentru verificarea sterilizării în pupinel**

10 0547

- Sterilizarea este evidențiată prin schimbarea culorii de pe indicator din verde în maro închis/negru, după expunerea la sterilizarea cu căldură uscată. Sterilizarea se realizează la 160°C/120 min, 170°C/60 min, 180°C/30 min.
- Linile sunt în diagonală - cu un spațiu de 11 mm între ele și grosime de 3mm. Benzile sunt versatile și aderă pe orice tip de împachetare.

**Chemical sterilization testing adhesive tape for dry heat**

- Sterilization is highlighted by shifting of the colors from the indicator from green to brown after exposing to dry heat sterilization. Sterilization is accomplished at a temperature of 160°C/120 min, 170°C/60 min, 180°C/30 min.
- Diagonal lines with a spacing of 11 mm and 3 mm thickness. Special adhesive formulated to withstand high temperature and humidity ensure excellent bond to paper, plastic, nonwovens, board, metal, glass and linen.



19 mm x 50 m  
autoadeziv/adhesive

**Indicator sterilizare aburi, autoclav**

50 0561

- Sterilizarea este evidențiată prin schimbarea culorii dungilor din roz în maro. Sterilizarea se realizează la temperaturi între 121° - 134° C

**Sterilization testing adhesive tape for steam**

- Sterilization is highlighted by shifting of the stripes from pink to brown. Sterilization is accomplished at temperatures between 121° - 134° Celsius.

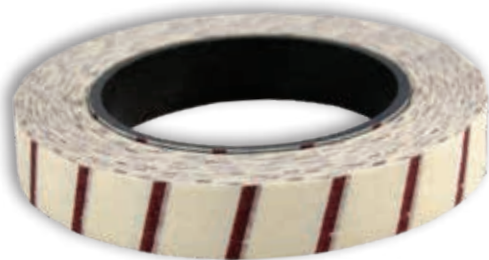

19 mm x 50 m  
autoadeziv/adhesive

**Indicator sterilizare Formaldehida  
Formaldehyde sterilization tape**

50 0112

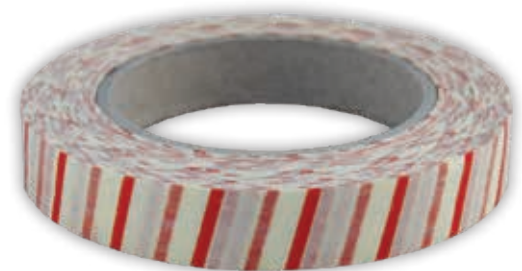

19 mm x 50 m  
autoadeziv/adhesive

**Indicator sterilizare EO ( Etilen Oxid )**

50 0106

- Sterilizarea este evidențiată prin schimbarea culorii dungilor din roșu în galben. Sterilizarea se realizează la temperaturi între 121° - 134° C.

**Sterilization testing adhesive tape for EO (Ethilen Oxid)**

- Sterilization is highlighted by shifting of the stripes from red to yellow. Sterilization is accomplished at temperatures between 121° and 134° Celsius.



Strip / Strip Dublu  
Strip / Double Strip

250 buc / pcs - cutie / box

**Indicator sterilizare căldură uscată  
Sterilization indicator for dry heat**

48 0547



Strip / Strip Dublu  
Strip / Double Strip

250 buc / pcs - cutie / box

**Indicator chimic clasa 6 abur**

10 1795

- Conceput pentru sterilizare cu abur

**Chemical indicator class 6 steam**

- Designed for sterilization with steam

Strip / Strip Dublu  
Strip / Double Strip

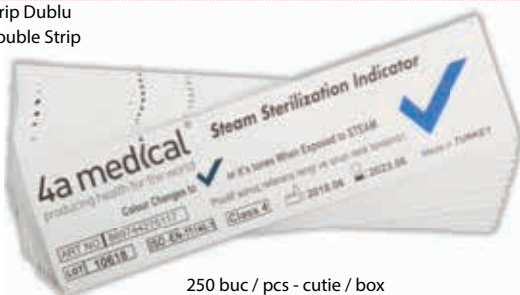

250 buc / pcs - cutie / box

**Indicator chimic clasa 4 abur**

10 1796

- Conceput pentru sterilizare cu abur

**Chemical indicator class 4 steam**

- Designed for sterilization with steam



• Strip 250 buc / pcs - cutie / box  
• Cu fereastră / windows 100 buc / pcs - cutie / box

**Indicator chimic clasa 5 abur**

10 1797

- Conceput pentru sterilizare cu abur

**Chemical indicator class 5 steam**

- Designed for sterilization with steam





- Testul Bowie-Dick trebuie utilizat:
- zilnic, dacă la autoclavă se sterilizează textile
- cel puțin o dată pe săptămână, la autoclavele care sterilizează instrumente
- după fiecare reparație a autoclavei
- Bowie-Dick test must be used:
- daily, if the autoclave will be used for sterilization of textiles
- at least once a week, for the autoclaves which sterilize instruments
- after every restoration

**Teste Bowie & Dick pentru testare autoclav**

50 0124

- Se folosește în autoclavul cu aburi pentru programele bowie and Dick, la testarea penetrării aburului în sterilizator cu descărcare dinamică de aer.
- Se bagă în autoclav, se dă drumul la aparat. Testul este cel albastru, înfășurat în foi de hârtie ( pus la mijloc ). Dacă se face sterilizarea, testul își schimbă culoarea din albastru în verde închis, în timpul fazei de difuzie dintr-un ciclu de sterilizare. Dacă sterilizarea nu este suficientă - rămâne albastru. Testul oferă o confirmare vizibilă a detectării prezenței aerului rezidual ( se pune între hartii ca să se vadă cât de bine pătrunde sterilizarea până în test), în urma unei monitorizări zilnice pentru 3.5 minute, la 134°C - 137°C. Nu trebuie să intre în contact cu lichidul.
- 1 test, Material: testul este din hârtie crep, fiind pus între foi de hârtie.

**Bowie & Dick autoclave test pack for pre-vacuum steam sterilizers**

- Use the steam autoclave for Bowie and dick programs for the testing of the penetration of the steam sterilizer with dinamic air discharge.
- Put the test into autoclav and turn on the device. The test is blue, wrapped in sheets of paper ( put in the middle ). If sterilization is done properly, the color changes from blue to dark green during the diffusion phase of sterilization cycle. If the sterilization is not proper-remains blue. The test detects the presence of residual air ( is put between sheets to see how well the sterilization penetrates the test ) after a daily monitoring for 3.5 minutes at 134°C - 137°C. Should not come into contact with the liquid.
- 1 test Material: the test is made from crepe paper, being placed between sheets of paper.



dimensiune / dimensions  
43 x 34 x 25mm



**Sigilator pungi**

3 1781

- Lățime utilă maximă 25 cm, inox, înălțime lipitură 1 cm
- Sealing machine for sterile bags**
- Sealing width 25 cm, sealing high 1 cm, stainless steel

**G133 Sterilizare Pungi Autosigilante • Sterilization Self-Sealed Pouches**



19mm x 50m

**Rolă adezivă fără indicator  
Tape without indicator**

100 1706



1 bucată 100

10 bucăți 10

11 mm diametrul / diameter

**Indicator biologic pentru controlul eficienței sterilizării în autoclav**

1784

- Conține spori bacterieni viabili de Geobacillus Stearothermophilus

**Biological indicator for autoclave sterilization efficiency control**

- Containing viable bacteriene spores of Geobacillus Stearothermophilus



50 mm x 200 m	10
75 mm x 200 m	8
100 mm x 200 m	8
150 mm x 200 m	4
200 mm x 200 m	4
250 mm x 200 m	2
300 mm x 200 m	2
350 mm x 200 m	2
400 mm x 200 m	2

**Rolă pungi sterilizare, Autoclav/EO**

• Hârtie de tip craft (60 g/m<sup>2</sup>) în partea inferioară peste care este lipit un film transparent copolimer, format din 5 straturi. Forța medie de rezistență: 3N

**Flat Reels, Steam/EO sterilization indicator**

• Kraft paper type (60 g/m<sup>2</sup>) in the inferior side on which a five-layer copolymer transparent film is glued. Average resistance force: 3N

0244



75 x 25 mm x 100 m	8
100 x 50 mm x 100 m	8
150 x 55 mm x 100 m	4
200 x 60 mm x 100 m	4

**Rola cu PLIU Sterilizare, autoclav/EO**

**Gussetted Reels, Steam/EO sterilization indicator**

1076



60 x 100 mm	40
75 x 250 mm	40
90 x 250 mm	30
150 x 250 mm	20
190 x 330 mm	20
200 x 400 mm	10
250 x 300 mm	10
300 x 400 mm	10
300 x 450 mm	10
250 x 400 mm	10
300 x 500 mm	10

100 buc/pcs  
TS EN868-5 / EN ISO 1



100 x 100 cm, albastru, verde, autoclav/EO, 250 buc / cutie	4
120 x 120 cm, albastru, verde, autoclav/EO, 125 buc / cutie	2
75 x 75 cm, intercalată alb-verde, autoclav/EO, 250 buc / cutie	6
105 x 100 cm, intercalată alb-verde, autoclav/EO, 250 buc / cutie	4

**Hârtie creponată pentru sterilizare**

1024

• Hârtie rezistentă recomandată pentru împachetarea materialului moale și a coșurilor cu instrumente în vederea sterilizării.

• Cului rezistente la procesul de sterilizare, fără solvent. Hârtia de împachetat este de unică folosință.

**Sterilization crepe paper for autoclave**

• Resistant paper recommended for packing soft material and basket tools for sterilization.

• Resistant colors to the sterilization process, without solvent. Disposable wrapping paper.

**Pungi autosigilante sterilizare indicator autoclav/EO 0621**

**Self-sealed pouches, steam/EO sterilization indicator**



Lăsați instrumentele să se usuce complet  
Leave the tools to completely dry

**Pungi nylon sterilizare pupinel** 0853  
Self-sealing nylon pouches for poupinel, dry heat sterilization

**Rolă pungi nylon sterilizare pupinel** 0874  
Flat reels for poupinel, dry heat sterilization

**ATENȚIE!!!** - Nu introduceți în pungă instrumentele ude sau apă. Imiditatea instrumentelor duce la arderea și explozia ambalajului! Timpul și temperatura optimă pentru sterilizare la căldură uscată este 160 °C (320 °F) timp de 2 ore sau 170 °C(340 °F) timp de o oră.

**ATTENTION!!!** - Do not put in the bag wet instruments or water. Humidity of the instruments leads to the burning and explosion of the packaging. The proper time for Dry-Heat sterilization is 160 C(320 F) for 2 hours or 170 °C(340 °F) for 1 hour.

**ORDIN Nr. 261 din 6 februarie 2007, Art. 48**

Toate dispozitivele medicale și materialele care urmează a fi sterilizate trebuie curățate și dezinfectate, înainte de a fi supuse unui proces de sterilizare standardizat.

Durata menținerii sterilității materialelor ambalate în cutii metalice perforate este de 24 de ore de la sterilizare, cu condiția menținerii cutiilor închise.

**ORDIN Nr. 261 din 6 februarie 2007, Art. 79. - (1)**

Durata menținerii sterilității materialelor ambalate în cutii metalice perforate este de 24 de ore de sterilizare, cu condiția menținerii cutiilor închise.

All medical devices and the materials to be sterilized must be disinfected and cleaned before being subjected to a standardized sterilization process.

The products will remain sterile in the welded plastic bags for 2 months from sterilization, subject to maintaining the integrity of the package.

G425 Sterilizatoare • Sterilizers



- Termostat reglabil 0-200°C
- Adjustable thermostat 0-200°C

**Sterilizator pupinel aer fierbinte**  
Hot air sterilizer

5 2080



- Termostat reglabil 9-200°C
- Adjustable thermostat 0-200°C

5 2081



25 x 13 x 4.5 cm

**Tăviță renală din plastic**  
Plastic kidney tray

500

1812-001



4 cm  
diametru / diameter

**Cutiută Inox**  
Gallipot small size

100

1262



25 x 14 x 4.5 cm  
700 ml  
gri / grey  
300 buc / pcs  
de unică folosință / for single use

**Tăviță renală din carton**  
Cardboard kidney tray, single use

1

1452-300



35 cm



25 cm



20 cm



15 cm

200 1256-15

200 1256-20

200 1256-25

100 1256-30

100 1256-35

**Tăviță renală, inox**  
Kidney tray, stainless steel



**Tavă inox**  
Steel tray



30 x 20 x 2.8 cm 10 1604-30x20

34 x 20 x 6 cm 10 1604-34x20

40 x 30 x 2.8 cm 10 1604-40x30

45 x 30 x 2.8 cm 10 1604-45x30

45 x 35 x 2.8 cm 10 1604-45x35



**Casoletă inox**  
Stainless steel drums



8 x 8 cm 20 1264-080x080

10 x 10 cm 30 1264-100x100

12 x 12 cm 9 1264-120x120

16 x 16 cm 6 1264-160x160



18 x 8 x 4 cm  
 20 x 10 x 4 cm 50

30 x 15 x 4 cm  
 32 x 16 x 6 cm  
 36 x 19 x 6 cm 10 **1543**



17 x 7 x 3 cm 50  
 20 x 10 x 4 cm 50  
 26 x 15 x 5 cm 20

1166

### Cutii instrumentar INOX

• Oțel inoxidabil. Grad ridicat de duritate. Fiind produsă din inox (conține cel puțin 11% crom), cutia este rezistentă la coroziune și la căldură/îngheț

#### Instruments Stainless Steel Boxes

• Stainless steel. High hardness. Being produce by steel ( contains at least 11% chrom ) the box is corrosion, heat/freeze resistant.

#### ORDIN Nr. 261 din 6 februarie 2007, Art. 48

Toate dispozitivele medicale și materialele care urmează a fi sterilizate trebuie curățate și dezinfectate, înainte de a fi supuse unui proces de sterilizare standardizat. Durata menținerii sterilității materialelor ambalate în cutii metalice perforate este de 24 de ore de la sterilizare, cu condiția menținerii cutiilor închise.

#### ORDIN Nr. 261 din 6 februarie 2007, Art. 79. - (1)

Durata menținerii sterilității materialelor ambalate în cutii metalice perforate este de 24 de ore de sterilizare, cu condiția menținerii cutiilor închise.  
 All medical devices and the materials to be sterilized must be disinfected and cleaned before being subjected to a standardized sterilization process.  
 The products will remain sterile in the perforated metallic boxes 24 hours from sterilization on condition to maintain the boxes closed.



255 x 245 x 100 mm      300 x 200 x 200 mm      400 x 200 x 200 mm

405 x 255 x 70 mm      460 x 800 x 520 mm      500 x 300 x 300 mm

540 x 255 x 50 mm

### Coș pentru sterilizare

• Oțel inoxidabil

#### Sterilizing basket

• Stainless steel

2 **1919**

**Sterilizator profesional UV**

• Pentru instrumentar, un sertar, 8W, alb

5 2330

**Professional UV sterilizer**

• For instruments, one drawer, 8W, white



40 x 24 x 18 cm

**i** Sterilizator cu raze ultraviolete pentru sterilizarea ustensilelor de manichiura, pedichiura, coafor si frizerie. Procesul de sterilizare se produce sub actiunea razelor UV care distrug germenii si bacteriile de pe instrumentele de lucru. Procesul de sterilizare dureaza 30-45 min.

Ultraviolet sterilizer for sterilizing manicure, pedicure, hairdressing utensils. The sterilization process occurs under the action of UV rays that destroy germs and bacteria on the working tools. The sterilization process takes 30-45 min.

**Autoclav sterilizare E8**

• 24L, Euronda, clasa B  
• 5 cicluri de sterilizare, greutate 48kg

1 2466

**Sterilization autoclave E8**

• 24L, Euronda, class B  
• 5 sterilization cycles, weight 48kg



460 x 455 x 610 cm



**Aspirator chirurgical portabil**

• Cu tub silicon autoclavabil, filtru antibacterian, vas colector cu capac 1litru, buton pentru puterea de aspirare, indicator de vaccum, 1.8 kg

12 2316

**Portable suction unit**

• With autoclavable silicone tube, antibacterial filter, collecting vessel with 1 liter lid, suction power button, vacuum indicator, 1.8 kg

270x190x130mm



1.5 litri / liters

**Apă demineralizată**  
Demineralised water

4 1694



1 litru / liter 10

1.5 litri / liters 6

**Apă distilată**

• Purity 99.98%, de uz casnic (pentru statiile de calcat), uz industrial, pentru instalatiile de racire, prepararea solutiilor de laborator, radiatoare si acumulatori auto, dilutie antigel

2207

**Distilled water**

• Purity 99.98%, for domestic use (for ironing stations), industrial use, for cooling installations, preparation of laboratory solutions, car radiators and accumulators, antifreeze dilution



100 comprimate x 500 mg  
100 caps x 500 mg

**Dezinfectant Cloramina T**  
Disinfectant Cloramina T

100 2066



pentru flacon 1 litru  
for 1 liter flacons

**Pompă dozaj pentru flacon 1 litru**  
Dosage pump for 1 liter flacons

12 0235





1 litru / liter

### Dezinfectant suprafețe, 15 0290 spălare și dezinfecție, concentrat

- Dezinfecția și spălarea suprafețelor ( pardoselii, mese, pereți, blocuri operatorii, instrumentar medical, săli de sport, vestiare, spații pentru producția și desfacerea produselor alimentare, a instalațiilor care necesită dezinfecția prin stergere sau pulverizare.
- Are dublu efect: dezinfectează și curăță simultan
- Concentratul se diluează în apă.
- Norma de aplicare pe mp este de 40 ml soluție de lucru prin pulverizare.

1 litru concentrat = 400 litri preparați

### Surface disinfectant and cleaner, concentrate

- Disinfecting and washings surfaces ( floors, table, walls) operating themselves, medical tools, gyms, locker rooms, spaces for food products production and selling, installations that require disinfecting by whipping or spraying.
- Has double effect: desinfects and cleans at the same time.
- The concentrate is diluted in water to be applied 40 ml of solution on m2 by spraying.

1 liter concentrate = 400 liters ready to use

50 tablete/tablets  
200 tablete/tablets

### Dezinfectant Clorigen 20 0097 1 tabletă = 5 litri soluție

- Dezinfectant pentru spații private și zone de sănătate publică, folosit la dezinfecția suprafețelor și obiectelor contaminate: pardoseli, laboratoare, bureți, lenjerie, vase, ustensile de laborator, grupuri sanitare , apă de fântână și de piscină.
- 1 tabletă se diluează în 5 L sau 3 L de apă, în funcție de efectul dorit.
- Greutate tabletă: 3,4 g (200 tablete)
- O tabletă eliberează 1,5 gr clor activ

### Disinfectant with Activ Chlorine 1 tablet = 5 solution

- Disinfectant for private spaces and public health areas used fo disinfecting contaminated surfaces and objects: floors, laboratories, sponges, underwear, dishes, laboratory tools, batchroom, fountains water and pool water.
- 1 tablet is diluted in 5L or 3L of water, depending on the desired effect
- Weight: 3,4 g (200 tablets)
- One tablet releases 1.5 g of active chlorine



1 litru / liter

### Detergent nespumant, 15 1126 concentrat

- Curățarea, dezinfectarea și dezodorizarea instrumentarului din inox și a suprafețelor din sticlă, gresie, faianță, tacâmuri.
- Are dublu efect: dezinfectează și curăță simultan. Concentratul se diluează în apă.
- Bactericid (0.25% la 5 min), Fungicid (1% la 15 min), Virucid (0.25% la 60 min, Microbactericid și Tuberculocid (2% la 15, respectiv 90 min)

1 litru concentrat = 125 litri preparați

### Detergent and disinfectant for surfaces, no-foam, colorless, odourless - concentrate

- Cleaning, disinfecting and deodorizing stainless steel tools and glass surfaces, porcelain, stoneware, earthenware, cutlery.
- Has double effect: desinfects and cleans at the same time. The concentrate is diluted in water.
- Bactericidal (0.25% at 5 min), Fungiciden (1% at 15 min), Virucidal (0.25% at 60 min), Microbactericid and tuberculocidal ( 2% at 15 and 90 min).

1 liter concentrate = 125 liters ready to use



1 litru / liter

### Detergent spumant, 15 1144 concentrat

- Curățarea, dezinfectarea și dezodorizarea instrumentarului din inox și a suprafețelor din sticlă, porțelan, gresie, faianță, tacâmuri.
- Are dublu efect: dezinfectează și curăță simultan. Concentratul se diluează în apă.
- Bactericid (0.25% la 5 min), Fungicid (1% la 15 min), Virucid (0.25% la 60 min), Microbactericid și Tuberculocid (2% la 15, respectiv 90 min).

1 litru concentrat = 500 litri preparați

### Detergent and disinfectant for surfaces, dezodorizant with foam - concentrate

- Cleaning, disinfecting and deodorizing stainless steel tools and glass surfaces, porcelain, stoneware, earthenware, cutlery.
- Has double effect: desinfects and cleans at the same time. The concentrate is diluted in water.
- Bactericidal (0.25% at 5 min), Fungicide (1% at 15 min), Virucidal ( 0.25% at 60 min ), Microbactericid and tuberculocidal ( 2% at 15 and 90 min).

1 liter concentrate = 500 liters ready to use



1 litru / liter

### Dezinfectant suprafețe, 15 0291 flacon cu spray

- Pentru curățarea și dezinfecția suprafețelor ( pardoseli, mese, pereți, tapițerii)
- Are dublu efect: dezinfectează și curăță simultan
- Se aplică cu spray-ul direct pe suprafață și se lasă să se usuce
- Nu necesită clătire.
- Bactericid ( 5 min ), Funcigic ( 5 min )

### Surface disinfectant spray

- For cleaning and disinfecting surfaces ( floor, tables, walls, upholstery )
- Has double effect: desinfects an cleans in the same time
- It is applied with the spray directly on the surface and let to dry.
- Does not require rinse.
- Bacatericidal ( 5 min ), Fungicide ( 5 min ).



1 litru / liter

### Dezinfectant rapid 15 1347 pentru suprafețe

- În domeniul medical, cosmetică, la dezinfecția suprafețelor, instrumentelor, aparatură medicală, mobilier, pereți, etc. Se folosește ca atare, nediluat.
- Efect Biocid: Bactericid conform SR EN 1276 nediluat timp de 5 min. • Fungicid conform SR EN 1275 nediluat timp de 5 min. • Micobactericid conform EN 14348, nediluat timp de 1 min. • Virulicid conform SR EN 14476 ca atare (nediluat), după un timp de contact de 1 minut, la temperatura de 20° Celsius pentru Adenovirus și Poliovirus.

### Surface disinfectant rapid

- In medical field, cosmetics, for surface disinfection, instruments, medical equipment, furniture, walls etc. It is used normally, undiluted.
- Biocidal effect: Bactericidal according to SR EN 1276, undiluted for 5 minutes. • Fungicide according to SR EN 1275, undiluted for 5 minutes. • Microbactericid according to EN 14348 , undiluted for 1 minute. • Virulicid according to SR EN 14476 normal ( undiluted ), after a contact time of 1 minute, at 20 degrees Celsius for Adenovirus and Poliovirus.





15  
1 litru / liter



100  
100 ml

### Dezinfectant și Antiseptic - mâini și tegumente, preparat

0293

- Pentru dezinfecția igienică a mâinilor înainte și după intervenții chirurgicale, înainte de injecții, vaccinări, înainte de perfuzii și transfuzii, pentru dezinfecția postoperatorie a plăgilor, a tegumentelor personalului din industria farmaceutică și cosmetică, a mâinilor elevilor și salariaților, a mâinilor persoanelor aflate în deplasare.
- Are dublu efect: dezinfectant și antiseptic. Pentru dezinfecția igienică a mâinilor se recomandă 3 ml timp de un minut, iar pentru dezinfecția chirurgicală a mâinilor se recomandă 5 ml timp de 2.5 minute; procedura se repetă de două ori.

### Disinfectant for hands and teguments, ready to use

- For hygienical disinfection of the hands before and after surgical interventions, before and after injections, baccines, before perfusions and transfusions, for postoperative disinfection of wounds, pharmaceutical and cosmetics personnel's skin, pupils' and employees' hands, the hands of people on the move.
- Has double effect: disinfectant and antiseptic. For hygienic disinfecting of the hands, it is recommended 3 ml for one minute and for surgical disinfecting of the hands it is recommended 5 ml for 2.5 minutes; the procedure is repeated two times.



1 litru / liter

### Săpun lichid dezinfectant și antiseptic Măini și tegumente Prestisept

15 1773

- se utilizează ca atare (nediluat) pentru dezinfecția igienică a mâinilor prin spălare în spațiile private și zonele de sănătate publică.
- Modul de aplicare: prin spălare, nediluat, timp de 3 minute.
- Pentru utilizatori profesionali și populație.

### Liquid soap disinfectant for hands and teguments Prestisept

- it is used undiluted for hygienical disinfection of hands by washing in private spaces and public health areas.
- How to apply: by washing, undiluted, for 3 minutes.
- For professional and normal use.



1 litru / liter

### Soluție IODINE "T"

15 1203

- Dezinfectant și antiseptic în igiena umană ce conține iod și se recomandă pentru: antiseptia rănilor sau arsurilor superficiale de mică întindere, tratament local pentru afecțiunile pielii sau mucoaselor infectate sau cu risc de infecție, antiseptia pielii din câmpul operator.
- Se utilizează ca atare ( pentru pansamente pe piele, timp de acțiune 1 minut ) sau diluat ( spălarea plăgilor superficiale - diluție 1/10 cu apă sau ser fiziologic; Irigarea plăgilor superficiale - soluție 2% cu apă sau ser fiziologic )

### IODINE "T" Solution

- Disinfectant and antiseptic containing iodine, used in human hygiene. Recommended as an antiseptic for superficial wounds and burns, for the local treatment of diseases of infected skin or mucosa / skin or mucosa with risk of infection, as a surgical antiseptic.
- Used as is ( for dressings on the skin - one minute action time ) or diluted ( for washing superficial wounds - diluted 1/10 with water or normal saline solution; for irrigation of superficial wounds - 2% solution with water or normal saline solution ).

## G146 Dezinfectant Instrumente • Instrument Disinfectant



1 litru / liter

### Dezinfectant instrumente concentrat

15 0292

- Dezinfecția instrumentarului medical, chirurgical, stomatologic și de diagnostic, prin imersie la temperatura ambiantă.
- Dezinfecția suprafețelor din sălile de operație, cabinete medicale.
- Are dublu efect: dezinfectează și curăță simultan
- Concentratul se diluează în apă
- Instrumentarul curățat de resturi organice se imersează în soluția de lucru.

1 litru concentrat = 200 litri preparați

### Instruments disinfectant concentrate

- Disinfection of medical tools, surgical tools, dental tools and diagnostic tools by immersion at an ambient temperature.
- Disinfection of operation rooms surfaces, medical cabinets.
- Has double effect: disinfects and cleans at the same time
- The concentrate is diluted in water
- The tools cleaned of organic left overs its immersed in the solution

1 liter concentrate = 200 liters ready to use



1 litru / liter

### Detergent enzimatic Enzioclean

15 2062

- Pentru spălarea instrumentarului chirurgical și de diagnostic. Complexul enzimatic din compoziție ajută la înlăturarea resturilor organice.

- Utilizare: Se recomandă o soluție de lucru obținută din 50 ml produs la 5 L apă. Concentrația soluției de lucru poate fi marită în funcție de gradul de murdărire al instrumentarului.

### Enzymatic cleaner Enzioclean

- For washing surgical and diagnostic instruments
- Usage: A working solution obtained from 50 ml of product in 5 L of water is recommended. The concentration of the working solution can be increased depending on the degree of soiling of the instrumentation.



46 x 91.5 cm  
61 x 91.5 cm

46 x 114.5 cm  
66 x 114.5 cm

### Covor adeziv pentru controlul contaminării

5 0529

- Utilizat pentru controlul contaminării în spații cu cerințe ridicate, cabinete medicale, stomatologice, laboratoare.
- Foițe cu suprafață lipicioasă care rețin praful și alte impurități
- 10 seturi x 30 foițe

### Sticky mat for contamination control

- Used for contamination control in spaces with high hygiene requirements, medical and dental offices, laboratories.
- Foils with a sticky surface that retain dust and other impurities
- 10 set x 30 sheets

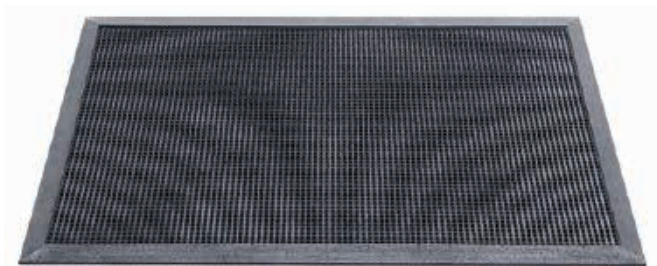

61 x 81 cm

60 x 100 cm

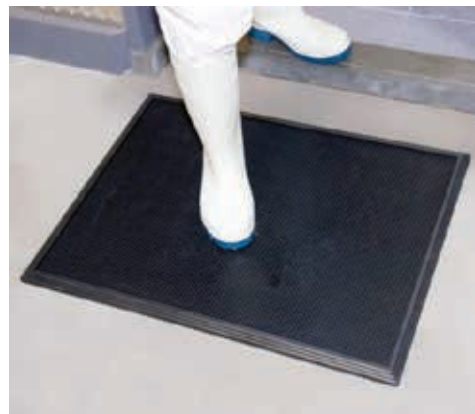

### Covor cauciuc pentru dezinfectanti

5 1371

- Curăță și igienizează pantofii și este recomandat la intrările în toate zonele de procesare a alimentelor.
- Miile de ventuze flexibile care formează presul asigură curățarea automată și dizlocă murdăria de pe talpa încălțămintei. În momentul pasirii pe ele, varfurile de cauciuc se îndoaie sub presiune și talpa încălțămintei se cufundă în soluție dezinfectantă - o acțiune dublă care nu permite ajungerea contaminării în zonele de procesare a alimentelor.
- Dimensiunile convenabile ale covorului dezinfectant se potrivesc la majoritatea ușilor.
- Ventuzele de pe partea inferioară împiedică covorul să alunece.
- Bordura perimetrală mai înaltă cu 0,635 cm decât cilii din care este format presul are rolul de a reține lichidul dezinfectant în pres. Covorul are o capacitate de 4,5l de soluție dezinfectantă.

### Entrance disinfectant rubber mat for disinfectant liquid

- Cleans and sanitizes shoes and is recommended at entrances to all food processing areas.
- Thousands of flexible fingers provide an automatic scrubbing action that dislodges contamination from footwear. As traffic passes, rubber tips bend under pressure to immerse soles in disinfectant solution, a double action that keeps contamination from reaching food processing areas.
- Convenient mat size that fits most doorways.
- Suction cups on underside prevents mat from shifting.
- Natural rubber compound for general purpose applications, designed to resist to most chemicals and variations in temperature
- Surrounding border stands >0,635 cm higher than finger-scrappers to contain liquid disinfectant. Mat holds 4.5 liters of disinfectant solution.



750 x 750 x 1.5mm

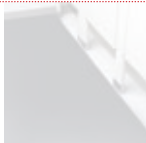

### Covor protecție din cauciuc

18 0702

- Utilizat pentru controlul contaminării în spații cu cerințe ridicate, cabinete medicale, stomatologice, laboratoare.
- Foițe cu suprafață lipicioasă care rețin praful și alte impurități
- 10 seturi x 30 foițe

### Protective rubber mat

- Used for contamination control in spaces with high hygiene requirements, medical and dental offices, laboratories.
- Foils with a sticky surface that retain dust and other impurities
- 10 set x 30 sheets

6 0.6m x 0.9m

1 0.9m x 1.5m

### Covor de intrare gri

2076

- Pentru absorbția apei, 3M

### Grey textile entrance mat

- For water absorption, 3M



portabil / portable  
 în limba română / in local language  
 pentru adulți și copii peste 8 ani / for adults and children over 8 years

dimensiuni / dimensions 303 x 216 x 89 mm  
 greutate / weight 2kg  
 fără electrozi / without electrodes

**AED7000** este un defibrilator automat extern, conceput pentru utilizare de către personalul autorizat, de un fizician/director medical care are pregătire în utilizarea AED.

Este prevăzut cu instrucțiuni audio prin difuzorul încorporat, pentru a oferi instrucțiuni operative și asistență utilizatorului pe durata defibrilării:

- nu este destinat folosirii pe pacienții minori;
- sunt utilizate doar baterii nereîncărcabile din litiu, cu durata extinsă de viață: M&B Part No. CR123A-4x2;
- suportă trei nivele de defibrilare (100J-150J-200J), două butoane funcționale, voce extinsă și solicitări vizuale pentru asistența operatorului, protecție de veghe pentru a preveni o defibrilare accidentală;
- este proiectat pentru a suporta mai puțin de 2500 descărcări/evacuări.

**AED7000** is an external automatic defibrillator designed for use by authorized staff, a physician / medical director who is prepared to use AED.

It is provided with audio instructions through the built-in loudspeaker to provide instructions operative and user assistance during defibrillation:

- is not intended for use on minors;
- only non-rechargeable lithium batteries with long life spans are used: M&B Part No. CR123A-4x2;
- supports three levels of defibrillation (100J-150J-200J), two functional buttons, extended voice and visual requests for operator assistance, wake-up protection to prevent accidental defibrillation;
- designed to support less than 2500 downloads / exits.

**Defibrilator automat extern AED7000**  
**Automatic external defibrillator AED7000**

1 1507

**Baterie Li-MnO2**

• Pentru defibrilator AED7000, nereîncărcabilă

**Li-MnO2 battery**

• For AED7000 defibrillator, non-rechargeable

10 1690



2.8Ah/12v DC



105 x 110 mm  
 2 buc./pcs

**Electrozi copii - pentru defibrilator**

• Cu spumă 1mm și reductor de tensiune

**Defibrillation electrodes for children**

• With 1mm foam and energy reducer

10 1509



105 x 155 mm  
 2 buc./pcs

**Electrozi adulți - pentru defibrilator**

• Cu spumă 1mm

**Defibrillation electrodes for adults**

• With 1 mm foam

10 1508



Str. C-tin Dragan no. 20, sector 3  
032855 Bucharest, ROMANIA

vetro@vetro.ro

+40 738 976704

www.vetro.ro

www.prima-info.ro

DENTAL  
MEDICAL  
LABORATORY  
COSMETICS  
VETERINARY



## Calendar 2022

### IANUARIE

L	M	M	J	V	S	D
					1	2
3	4	5	6	7	8	9
10	11	12	13	14	15	16
17	18	19	20	21	22	23
24	25	26	27	28	29	30
31						

### FEBRUARIE

L	M	M	J	V	S	D
	1	2	3	4	5	6
7	8	9	10	11	12	13
14	15	16	17	18	19	20
21	22	23	24	25	26	27
28						

### MARTIE

L	M	M	J	V	S	D
	1	2	3	4	5	6
7	8	9	10	11	12	13
14	15	16	17	18	19	20
21	22	23	24	25	26	27
28	29	30	31			

### APRILIE

L	M	M	J	V	S	D
				1	2	3
4	5	6	7	8	9	10
11	12	13	14	15	16	17
18	19	20	21	22	23	24
25	26	27	28	29	30	

### MAI

L	M	M	J	V	S	D
						1
2	3	4	5	6	7	8
9	10	11	12	13	14	15
16	17	18	19	20	21	22
23	24	25	26	27	28	29
30	31					

### IUNIE

L	M	M	J	V	S	D
			1	2	3	4
5	6	7	8	9	10	11
12	13	14	15	16	17	18
19	20	21	22	23	24	25
26	27	28	29	30		

### IULIE

L	M	M	J	V	S	D
				1	2	3
4	5	6	7	8	9	10
11	12	13	14	15	16	17
18	19	20	21	22	23	24
25	26	27	28	29	30	31

### AUGUST

L	M	M	J	V	S	D
					1	2
3	4	5	6	7	8	9
10	11	12	13	14	15	16
17	18	19	20	21	22	23
24	25	26	27	28	29	30
31						

### SEPTEMBRIE

L	M	M	J	V	S	D
			1	2	3	4
5	6	7	8	9	10	11
12	13	14	15	16	17	18
19	20	21	22	23	24	25
26	27	28	29	30		

### OCTOMBRIE

L	M	M	J	V	S	D
						1
2	3	4	5	6	7	8
9	10	11	12	13	14	15
16	17	18	19	20	21	22
23	24	25	26	27	28	29
30	31					

### NOIEMBRIE

L	M	M	J	V	S	D
	1	2	3	4	5	6
7	8	9	10	11	12	13
14	15	16	17	18	19	20
21	22	23	24	25	26	27
28	29	30				

### DECEMBRIE

L	M	M	J	V	S	D
			1	2	3	4
5	6	7	8	9	10	11
12	13	14	15	16	17	18
19	20	21	22	23	24	25
26	27	28	29	30	31	

Pozele prezentate în acest catalog au un caracter informativ și nu creează informații contractuale, întrucât designul produselor poate varia și pot exista diferențe între acestea și produsele existente la un moment dat în stoc!

The pictures presented in this catalog are for illustration purpose only and do not create contractual obligations because the design of the products may vary and there may be differences between them and the existing products in stock!