

PRIMA[®]

Catalog Stomatologie





Vetro Design este o companie cu peste douăzeci și cinci de ani de experiență profesională și peste șazeci de angajați, operând exclusiv cu capital românesc. Compania noastră este un principal importator, distribuitor și exportator de dispozitive medicale, produse de laborator, produse medico-dentare și veterinare, articole profesionale pentru industria de înfrumusețare, produse de curățenie și igienă din România.

Cu peste 10.000 de metri pătrați de spațiu de depozitare, birouri și producție, facilități de import și distribuție dedicate, Vetro Design este cel mai mare depozit de produse de unică folosință destinate domeniului sănătății din țară. În plus, echipa noastră eficientă asigură o distribuție rapidă și constantă către toți clienții din teritoriul Uniunii Europene, dar și către cei din întreaga lume.

Suntem producători:

La nivel național, suntem printre puținii **producători de truse sanitare** de prim ajutor, kituri de înlocuire, truse sanitare auto, truse de prim ajutor auto DIN 13164 (omologate la nivel internațional) și truse de urgență pentru cabinetele stomatologice. Toate produsele sunt avizate de Ministerul Sănătății și se diferențiază de cele concurente prin calitatea conținutului marca PRIMA.

Din anul 2016 Vetro Design confecționează uniforme profesionale. Utilizând materiale textile calitative, echipamente performante și având un personal specializat, am creat o gamă care include uniforme medicale, îmbrăcăminte de lucru pentru hoteluri și industria alimentară, uniforme pentru saloane și îmbrăcăminte de protecție. Uniformele profesionale PRIMA sunt disponibile într-o varietate de materiale, culori și modele. *Penru că apreciam dorința clienților noștri de a fi unici, putem personaliza toate uniformele din colecția noastră prin broderie, imprimare sau serigrafie și execută modele noi pe comandă.*

Oferim soluția optimă:

Ca importator direct și producător, Vetro Design oferă prețuri competitive și cunoaște foarte bine piețele produselor sale. De asemenea, compania noastră se remarcă prin soluții de cumpărare facile, oferindu-le clienților toate produsele necesare dintr-o singură sursă, ceea ce economisește timp și bani. În plus, toate articolele noastre sunt supuse unui control strict al calității și respectă standardele Uniunii Europene.

Echipa Vetro Design este formată din persoane ambițioase și profesioniste, pregătite să îi sprijine pe clienți cu informații despre produsele din portofoliul companiei, solicitări de articole noi și promoții curente.

Pentru a ne îmbunătăți constant produsele, a avea o gamă completă de articole profesionale, dar și pentru oportunitatea de a ne cunoaște mai bine clienții, participăm în fiecare an la cele mai importante târguri și expoziții de specialitate naționale și internaționale.

Mărcile noastre:

Principalul brand al companiei, **PRIMA**, este bine cunoscut în România. Cu peste 3.000 de articole comercializate sub acest nume, marca și-a creat o imagine puternică pe piața autohtonă. Am lansat brandul **PRIMA** în anul 2003 din necesitatea de a controla nivelul de calitate promis și de a încuraja încrederea clienților în specificațiile tehnice ale produselor din oferta noastră.

Marca **VIORA** cuprinde articole și soluții de curățenie. Folosind o parte a verbului a „înviara”, numele mărcii exprima ideea de prospețime obținută ca urmare a utilizării produselor noastre.

Sub marca **ALINTA** se regăsesc produse destinate vânzării cu amănuntul. Aceasta a fost introdusă pe piața românească în anul 2007, iar numele ales ca o sugestie a beneficiilor oferite: a alina durerea, respectiv a alina consumatorul.

Viziune, misiune și valori:

Viziunea noastră constă în a deveni un cadru de referință pentru toate domeniile în care ne desfășurăm activitatea, creând valoare pentru clienții, partenerii, colegii și comunitatea noastră. Oferind numai produse care respectă standarde stricte de calitate, suntem permanent preocupați să atingem și să depășim așteptările clienților noștri, să fim soluția optimă și partenerul de afaceri preferat.

Misiunea noastră este să îi întâmpinăm pe clienții noștri cu un portofoliu complet de produse profesionale dedicate domeniilor de sănătate, înfrumusețare, igienă și curățenie. Îmbunătățind în mod continuu performanța globală a organizației, scopul nostru este de a ne apropia de nevoile și dorințele dumneavoastră, oferindu-vă produse de calitate superioară și o colaborare de încredere.

Valorile după care ne ghidăm activitatea zilnică sunt respectul față de clienții noștri, siguranța și gradul de inovație al produselor oferite, respectiv excelență datorată investițiilor pe care le facem în dezvoltarea companiei. La acestea se adaugă pasiunea, perseverența și integritatea unei echipe unite de profesioniști.

With over twenty-five years of professional experience and over 60 employees, **Vetro Design** is a company operating exclusively with Romanian capital. Our company is a leading importer, distributor and exporter of medical devices and laboratory products, dental and veterinary articles, professional beauty products as well as cleaning and hygiene products.

With over 10,000 square meters of storage space, offices and production, dedicated import and distribution facilities, Vetro Design is the largest warehouse for health-related single use products in the country. In addition to this, our efficient team ensures a fast and constant distribution to all of our customers in the European Union, but also to those around the world.

We are manufacturers:

At national level, we are among the few **manufacturers of first aid kits**, replacement kits, car kits, DIN 13164 first aid kits (internationally approved) and emergency kits for dental surgeries. All products are approved by the Ministry of Health and differentiate from those of the competitors due to the quality of the PRIMA brand content.

Internationally, **Vetro Design produces and sells professional uniforms**. Using only quality textiles, high performance equipment and specialized staff, we have created a range that includes medical uniforms, work clothing for hotels and the food industry, uniforms for salons and protective clothing.

Professional PRIMA Uniforms are available in a variety of materials, colors and designs. Because we appreciate our clients' desire to be unique, all the uniforms in our collection can be personalised with embroidery, printing or screen printing. We also offer tailored designs.

We offer the optimal solution:

As a direct importer and manufacturer, Vetro Design offers competitive prices and knows its product markets very well. Our company stands out due to the easy buying process which provides customers with all necessary products from a single source, saving them time and money. Additionally, all our articles are subject to a strict quality control and comply with the European Union standards.

The Vetro Design team comprises ambitious and professional individuals, ready to support customers with all relevant information about the company's products, new article requests and current promotions.

In order for us to constantly improve our products, to have a full range of professional articles and for the opportunity to know our customers better, every year we take part in the most important national and international trade fairs and exhibitions.

Our brands:

Because of our need to control the promised quality level and to encourage customer confidence in the technical specifications of our products, in 2003 we created **PRIMA** – the main brand of our company. With over 3,000 articles sold under this name, the brand has rapidly grown and is now well known in Romania.

Our second brand, **VIORA**, extends over a range of cleaning articles and solutions. The brand name expresses the idea of freshness obtained from the use of our products.

The brand **ALINTA** includes retail products. It was introduced to the Romanian market in 2007 and the name was chosen as a suggestion of the benefits offered: to alleviate pain, to comfort the client.

Vision, mission and values:

Our vision is to become a benchmark in all our lines of work, creating value for our customers, partners, colleagues and our community. By only offering products that meet strict quality standards, we are constantly concerned to reach and exceed our customers' expectations, to be the optimal solution and the preferred business partner.

Our mission is to meet our customers with a complete portfolio of professional products dedicated to health, beauty, hygiene and cleanliness. By continuously improving our organization's overall performance, our goal is to understand our customers needs and desires, delivering superior quality products and a trusting collaboration.

The values we guide our day to day activity by are the respect for our customers, the safety and the degree of innovation of the products offered, and the overall excellence deriving from the investments we make in the company's development. To these we add the passion, perseverance and integrity of a team of professionals.

**Stomatologie cabinet**

1-41

**Tehnică dentară**

42-47

CUPRINS

Conuri hârtie și Gutta Percha	1	- Pivoți endodontici	20
Consumabile stomatologie	2-5	Anse detartraj	21
- Aspiratoare salivă	2	Profilaxie, articole	22-25
- Microaplicatoare	2, 4	- Periuțe profilaxie	22
- Rulouri bumbac	3	- Materiale profilaxie	22, 23
- Tăvițe unică folosință	3	- Igienă dentară	24, 25
- Materiale auxiliare	4, 5	Materiale stomatologice	26-32
Implantologie și chirurgie	6-7	- Tratament canal	26
- Ace atraumatice	6	- Endodontice	27
- Seringă anestezie	6	- Restaurative	27, 28, 29
- Cutii inox instrumentar dentar	6	- Protetică - materiale amprentă, vârfuri mixare	30, 31
- Terapie cald-rece	7	- Hârtie articulații	31
Matrici și pene dentare	8-13	- Materiale de amprentă	32
- Matrici dentare conturate	8, 9, 10, 11	Sisteme de lustruire	33
- Matrici ortodonție	11	Gume polizare	34
- Matrici dentare bandă	12	Freze dentare	35-36
- Pene fixe	12, 13	- Freze carbid	35
Instrumentar stomatologic	13-18	- Freze diamantate	35, 36
- Chiurete și fuloare inox	13	Restaurări coroane	37-38
- Foarfeci și pense inox	14	Echipment cabinet - unituri	39
- Port ac suturi chirurgicale	15	Protecție medic și pacient	40-41
- Instrumentar stomatologic	15, 16	- Vizie protecție	40
- Kituri stomatologice sterile	16	- Bavete pacienți	41
- Elevatoare	16	- Protecție scaun consultație	41
- Clești dentari - adulți	17	Tehnică dentară	42-47
- Clești dentari - copii	18	- Spatule, boluri și suportți mixare	42
- Ciupitor de os	18	- Dinți artificiali	44
Endodonție	19-20	- Accesorii prelucrare și lustruire	44
- Ace de canal	19	- Instrumentar pentru ceramică	44
- Cutii și caserole medicale	19	- Materiale tehnică dentară	45, 46, 47

**Dental practice**

1-41

**Dental laboratory technology**

42-47

TABLE OF CONTENTS

Paper and Gutta Percha points	1	- Endodontic posts	20
Disposable dental supplies	2-5	Dental scalers	21
- Saliva ejectors	2	Prophylaxis products	22-25
- Micro applicators	2, 4	- Prophylaxis brushes	22
- Cotton rolls	3	- Prophylaxis materials	22, 23
- Disposable trays	3	- Dental hygiene	24, 25
- Auxiliary dental materials	4, 5	Dental materials	26-32
Implantology and surgery	6-7	- Root canal treatment	26
- Dental needles	6	- Endodontic	27
- Anesthetic syringe	6	- Restorative	27, 28, 29
- Dental boxes for instruments	6	- Dental prosthesis - impression materials, mixing tips	30, 31
- Hot and cold therapy	7	- Articulating paper	31
Dental matrices and wedges	8-13	- Impression	32
- Contoured dental matrices	8, 9, 10, 11	Polishing systems	33
- Orthodontic materials	11	Dental polishers	34
- Contoured Strips dental matrices	12	Dental burs	35-36
- Fixing wedges	12, 13	- Carbide burs	35
Dental instruments	13-18	- Diamond burs	35, 36
- Bone cutters	13	Dental restoration	37-38
- Forceps and scissors	14	Medical equipment - dental units	39
- Surgical needle holder	15	Doctor and patient protection	40-41
- Dental instruments	15, 16	- Protection face shields	40
- Dental sterile kits	16	- Patient bibs	41
- Root elevators	16	- Dental chair protection	41
- Forceps - adults	17	Dental tehnic	42-47
- Forceps - children	18	- Spatulas, mixing pads and bowls	42
- Dental rongeur	18	- Artificial teeth	44
Endodontics	19-20	- Processing and polishing accessories	44
- Dental files	19	- Dental laboratory technology materials	45, 46, 47
- Medical boxes and drums	19		

G004 Conuri Gutta Percha • Gutta Percha Points



.02
15-40
120 buc / pcs

Conuri Gutta Percha 10 0512
Assorted GuttaPercha points



.02
45-80
120 buc / pcs

Conuri Gutta Percha 10 0998
Assorted Gutta Percha points



.04
15-40
60 buc / pcs

Conuri Gutta Percha 10 0676
Assorted Gutta Percha points



.06
15-40
60 buc / pcs

Conuri Gutta Percha 10 0677
Assorted Gutta Percha points



• Gutta Percha (palaquium) este o specie de arbore tropical, nativ din Asia de Est și nordul Australiei, din sudul Taiwanului, până la Peninsula Malay și estul Insulelor Solomon. Din punct de vedere chimic, gutta-percha este un polimer de isopren sau poli-isopren. Proprietatea de bioinertie, de fermitate, datorită căreia materialul este potrivit pentru cablurile marine a condus la concluzia că nu reacționează în interiorul corpului uman, astfel fiind folosit pentru o serie de dispozitive chirurgicale și pentru aplicații dentare în tratamentul de canal. Acesta este materialul predominant folosit pentru a obtura sau umple spațiul gol din interiorul rădăcinii unui dinte după ce a fost supus tratamentului endodontic. Proprietățile sale fizice și chimice precum fermitatea, bio-compatibilitatea, punctul de topire, ductibilitatea și maleabilitatea îi conferă acestuia un rol important în domeniul endodontic.

• Gutta-percha (Palaquium) is a genus of tropical trees native to Southeast Asia and northern Australasia, from Taiwan south to the Malay Peninsula and east to the Solomon Islands. Chemically, gutta-percha is a polyterpene, a polymer of isoprene, or polyisoprene, specifically (trans-1,4-polyisoprene). The same bioinertness property that made it suitable for marine cables also means it does not readily react within the human body, and consequently it is used for a variety of surgical devices and for dental applications during root canal therapy. It is the predominant material used to obturate, or fill the empty space inside the root of a tooth after it has undergone endodontic therapy. Its physical and chemical properties, including but not limited to its inertness and biocompatibility, melting point, ductility and malleability, afford it an important role in the field of endodontics.

G005 Conuri Hârtie • Paper Points



.02
15-40
200 buc / pcs

Conuri hârtie asortate 10 0511
Assorted paper points



.02
45-80
200 buc / pcs

Conuri hârtie asortate 10 0999
Assorted paper points



.04
15-40
60 buc / pcs

Conuri hârtie asortate 10 0678
Assorted paper points



.06
15-40
60 buc / pcs

Conuri hârtie asortate 10 0679
Assorted paper points

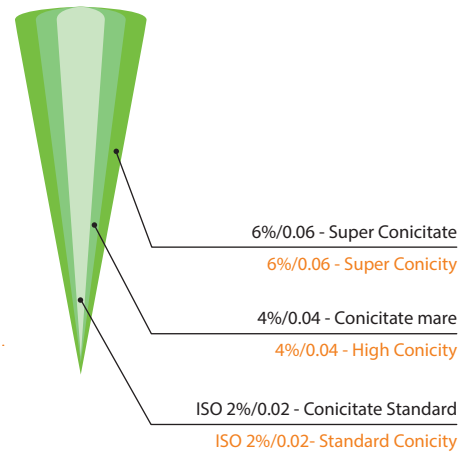

• Sunt ideale pentru obturarea canalului radicular. La vârful conului 9 d1), diametrul corespunde mărării ISO, dar apoi conicitatea este din ce în ce mai mare față de punctul ISO.

• Ideal for root canal obturation. At the apex of the 9 cone d1) diameter corresponds to the ISO size, but then the coning is increasingly higher than ISO point.



L16 x W14 x H 11.5

Dispenser aspiratoare salivă

- Plexiglass, transparent, cu capac.
- Capacitate 250 aspiratoare.

Saliva ejector dispenser

- Transparent plexiglass, with cover.
- Capacity of 250 pieces.

20 1634



15 cm - 100 buc / pcs

Aspirator salivă cu cap detașabil

10 0231

- Capatul se scoate ușor pentru a crește volumul aspirației când este cazul.
- Fir metalic rezistent și ușor de modelat. Oferă confort pacientului.
- Roșu, albastru, galben, verde, transparent.

Saliva ejectors with detachable head

- The end is easily removed to increase the volume of aspiration when necessary.
- Durable wire and easily molded. Provide patient comfort.
- Red, blue, green, yellow, clear.



200 buc / pcs

Vârfuri pentru seringă

30 1359

- Vârfurile au o cameră interioară pentru apă care se atașează la seringă, eliminând contaminarea apei și oferind pulverizare de aer/apă superioară.

Syringe tips

- The tips have an inner core water chamber that seats into the syringe, eliminating water contamination and delivering superior air/water spray.



160 x 11 mm
25 buc / pcs

Canule aspirator chirurgical universale

100 1639

Universal tips for dental surgical aspirator



100 buc / pcs

Vârfuri intraorale

- Galbene

500 1638

Intraoral mixing tips

- Yellow



S (5-6 mm) / L (9-10 mm)
3.2 x 14 mm
100 buc / pcs

Perii aplicatoare pentru mâner
Disposable brush tips for holder

250 1724



1 buc / pcs 50 buc / pcs
142 x 13 x 6 mm

Mâner pentru perii aplicatoare din policarbonat
Polycarbonate holder for brush tips

30 1721



37 x 10 mm

Rulouri bumbac rigide

• Sterilizabile

Starched cotton rolls

• Sterilizabile

1000 buc / pcs

30 0247



Dispenser rulouri bumbac

• Plexic transparent, igienic

Transparent cotton roll dispenser

• Plexiglass, hygienic and transparent

40 0296

38 x 10 mm
1000 buc / pcs



Rulouri bumbac împletite

Braided cotton dental rolls

60 1061



6 cutiute/boxes



Bulete de vată

10 1818

- Absorbante
- Nr. 1 - diametrul 4 mm
- Nr. 2 - diametrul 5.5 mm

Cotton balls

- Absorbent
- No.1 - 4 mm diameter
- No. 2 - 5.5 mm diameter

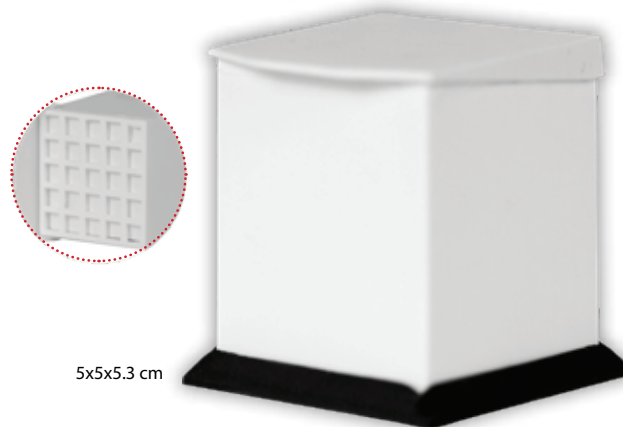

5x5x5.3 cm

Dispenser bulete de vată

- Orificii de mărime medie cu arc
- Autoclavabil

Cotton pellets dispenser

- Medium holes, with spring
- Autoclavable

10 2022

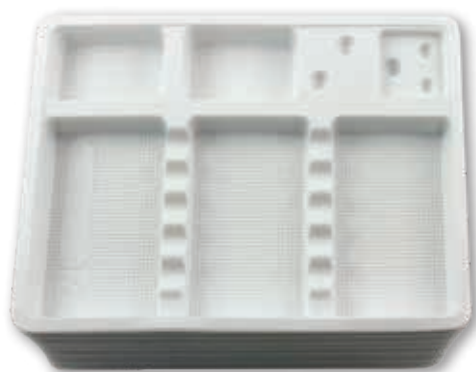

190 x 150 x 17 mm
100 buc / pcs

Tăvițe unică folosință nervurate

Disposable trays with ribbed bottom

4 0948



284 x 183 x 17 mm
100 buc / pcs



100 buc / pcs

S (alb - 1 mm) M (verde - 1.5 mm) L (albastru - 2 mm)
S (white - 1 mm) M (green - 1.5 mm) L (blue - 2 mm)

Aplicatoare cu puf, pentru bonding demineralizant

128 1188

Disposable applicators for cavity lining



200 buc / pcs

S (alb - 1 mm) M (verde - 1.5 mm) L (albastru - 2 mm)
S (white - 1 mm) M (green - 1.5 mm) L (blue - 2 mm)

Micro-aplicatoare cu puf pentru bonding demineralizant

100 1725

Micro-applicators with demineralizing bonding powder



albastru / blue

roz / pink

50 x 110 mm
100 buc / pcs

Periute aplicatoare de unică folosință

• Unghi și lungime reglabile, lungime periuța 9-10 mm.

Disposable micro brushes

• Adjustable angle and length, brush length 9-10 mm.

128 1357



M (verde - 1.5 mm)
M (green - 1.5 mm)

Dispenser cu 100 aplicatoare cu puf

• Plexic transparent igienic.

Dispenser with 100 applicators

• Hygienic and transparent.

32 0340



L - 120 x 53.5 x 18 mm
S - 114 x 42 x 17 mm

Departator bucal cu mâner

• Autoclavabil, transparent, plastic, pentru adulți, 1 pereche.

Cheek retractor with handle

• Autoclavable, clear, with handle, made of plastic, for adults, 1 pair.

200 1360



L - 130 x 92 x 21 mm
M - 118 x 85 x 17 mm
S - 97 x 70 x 15 mm

Departator bucal Bicomisural

• Autoclavabil, transparent, plastic, pentru adulți, 1 pereche.

Bicomusural cheek retractor

• Autoclavable, clear, made of plastic, for adults, 1 pair.

200 1361



430 x 430 x 250 mm

Gutieră din plastic pentru albit dinții

• Alb transparent, moale, elastică, 1 pereche.

Teeth whitening tray

• Clear white, soft, elastic, 1 pair.

500 1362



3.5 x 21.5 cm
500 buc / pcs

Folii plastic pentru protecție senzori digitali

40 1374

• Nu sunt sterile, de unică folosință.

• Previn contaminarea încrucișată, rezistente și flexibile.

Plastic folis for digital sensor protection

• Non sterile, for single use only.

• Prevent cross contamination, tough and flexible.



180 m x 10 cm
1 rolă / roll

Rola film protecție

• Albastra transparent, 1200 folii pretăiate, 15 cm lungime.

Universal barrier film

• Clear blue, 1200 precut sheets, 15 cm legth.

8 1365



240 x 135 x 180 mm
alb / white

Dispenser rolă film protecție

12 1366

Barrier film dispenser



50 buc / pcs

Seringa pentru injectare tratament cu flour și curățare dinți

Fluoride treatment syringe

25 1798-1

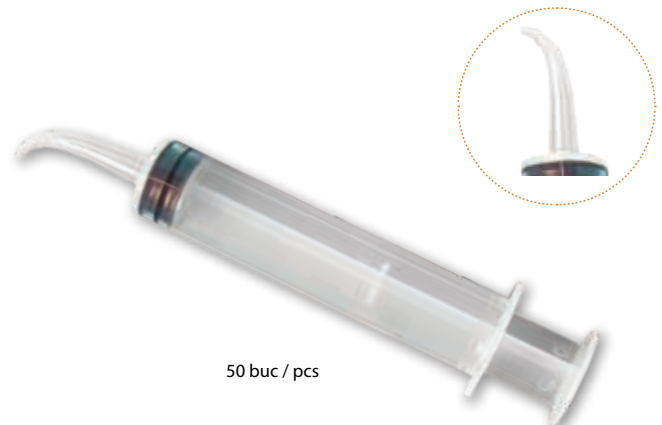

50 buc / pcs

Seringă pentru material de impresie și ciment

Impression material injection syringe

20 1798-2



XXS - 0.26 x 12 mm
 XS - 0.31 x 16 mm
 S - 0.31 x 21 mm
 L - 0.31 x 25 mm
 M - 0.41 x 25 mm
 XL - 0.41 x 35 mm
 XXL - 0.41 x 38 mm

needle size	27G	30G	31G
12mm	*		31G (0.26x12mm) 100 PCS
16mm	*	30G (0.31x16mm) 100 PCS	
21mm	*	30G (0.31x21mm) 100 PCS	
25mm	27G (0.41x25mm) 100 PCS	30G (0.31x25mm) 100 PCS	
30mm	*	*	
35mm	27G (0.41x35mm) 100 PCS		
38mm	27G (0.41x38mm) 100 PCS		
40mm	*	*	

Ace atraumatice

• Filet metric

Disposable Dental Needles

• Metric screw

50 0855



Seringă pentru anestezie

• Oțel inox, cu 2 vârfuri, 3 inele, șurub metric și inch

Anesthetic syringe

• Stainless steel, with 2 tips, 3 rings, metric and inch screw type

10 1075



Seringă anestezie intraligamentară

• Tip pistol
 • Inox

Anesthetic syringe

• Pistol type
 • Stainless steel

5 2318



9 x 4 x 2 cm

40

5 x 2 x 1 cm

100



10 x 4 x 5.5 cm

Cutie freze și ace
Box for cutters and needles

1160

Cutie Endo
Endo box

100 1159



200 ml

Spray rece

24 0910

- Oferă răcire imediată și îndepărtează rapid durerea cauzată de lovituri la nivelul țesuturilor moi. Folosit cu succes pentru îndepărtarea imediată a durerilor cauzate de întinderi, entorse și luxații.
- Compoziție: 15-25% Propan, 15-25% Iso-Butan, 45-50% Dimetileter

Cold spray

- The gel provides immediate cooling and effectively relieves pain caused by soft tissues injuries. Successfully used for immediate relief of pain caused by stretching, cricks and sprains.
- Composition: 15-25% Propane, 15-25% Iso - Butane, 45-50% dimethylether.



200 ml

Spray rece

10 1586

- Doză cu prelungitor 10 cm.
- Se pulverizează pe o dischetă de bumbac. Se formează un strat de gheață, care se va aplica în cavitate.
- Dacă reacția este dureroasă, nervul este activ. Lipsa de reacție sugerează că nervul este inactiv.

Cold spray

- Ready to use, 10 cm long spray nozzle
- Spray on a cotton pad. A layer of ice will form, which will be applied in the cavity.
- If the reaction is painful, the nerve is active. Lack of reaction suggests that the nerve is inactive.



15.5 cm

Pungă cu gheață sau apă caldă

50 2145

- Pentru calmarea diverselor dureri
- Pliabilă, cu capac care se înșurubează

Ice or hot water bag

- Used to relieve various pains
- Foldable, with screw cap



15 x 23 cm
260 gr

36

13 x 15 cm
105 gr

72

Pachet gheață instant

1114

- Hematoame, entorse, leziuni, hiper termice și alte cazuri în care se cere aplicare de strat rece, cu acțiune analgezică locală. Poate fi folosit imediat - nu necesită congelare prealabilă. Ușor de folosit - doar strângeți, spargeți punga cu apă din interior și agitați pentru activare
- Compoziție: Amestec de săruri nitrogene și apă

Instant ice cold pack

- Hematomas, sprains, injuries hyper thermals and in other cases where it is necessary applying a cold layer with local analgesic. Can be used immediately - does not require prior freezing. Easy to use - just tighten, brake the bag of water inside and shake to activate
- Composition: mix of nitrogenous salts and water



14 x 18 cm
230 gr

Pungă gheață instant EASY ICE

243 1114

- Nitrat de amoniu și apă
- Pentru uz extern

Instant Ice Cold Pack

- Amonium nitrate and water
- For external use



14 x 18 cm

Pungă gel cald-rece DISPOGEL

25 1222

- Propilenglicol și apă
- Pentru uz extern

Gel pack hot-cold DISPOGEL

- Propylene glycol and water
- For external use



35 x 7 mm

28 x 8 mm

Matrici ivory drepte perforate, inox

• Set 12 tipuri, transparente.

Straight ivory matrix perforated, stainless steel

• 12 types set, transparent.

10 1273



120 buc / pcs

Matrici conturate Mylar premolari și molari

• Set 8 tipuri, transparente.

Contoured Mylar matrices premolars and molars

• 8 types set, transparent.

10 1393



Port matrice Ivory, inox

• Ajută la fixarea matricilor în poziția dintelui.

Matrix retainers for Ivory bands, stainless steel

• Helps holding a matrix band in the tooth position.

10 1274



mărimi / sizes:
1, 2, 3, 4

grosime / thickness
50 μm

12 buc / pcs

Matrici Ivory conturate perforate, inox

• Anatomice, pre-formate în 4 mărimi

• Oferă condiții ideale pentru refacerea punctelor de contact.

Contoured Ivory matrices perforated, stainless steel

• Are pre-formate anatomical in 4 sizes.

• Offers ideal conditions for restoring the contact points.

10 1391



50 μm
30 buc / pcs

Matrici conturate metalice - premolari
Contoured metal matrices - premolars

10 1392-PREM



50 μm
30 buc / pcs

Matrici conturate metalice - molari
Contoured metal matrices - molars

10 1392-MOLAR



50 µm
16 buc / pcs

Matrici conturate metalice cu mâner de fixare – premolari

10

1394-PREM

Contoured metal matrices with fixing clamp – premolars



50 µm
16 buc / pcs

Matrici conturate metalice cu mâner de fixare – molari

10

1394-MOLAR

Contoured metal matrices with fixing clamp – molars



50 µm
16 buc / pcs

Matrici conturate Mylar cu mâner de fixare – premolari

10

1395-PREM

Contoured Mylar matrices with fixing clamp – premolars



50 µm
16 buc / pcs

Matrici conturate Mylar cu mâner de fixare – molari

10

1395-MOLAR

Contoured Mylar matrices with fixing clamp – molars



50 µm
50 buc / pcs

Matrici conturate metalice secționale, asortate & inel

480

1388-SEC-AST

• Mici, mici cu bordura, medii, medii cu bordura, mari, mari cu bordură.

Contoured metal matrices, sectional, assorted & Ring

• Small, small with ledge, medium, medium with ledge, large, large with ledge.



50 µm
18 buc / pcs

Matrici conturate metalice tip şa, asortate & arc clip

480

1388-TSA-AST

• Mici, medii, mari.

Contoured metal matrices, saddle type, assorted & spring clip

• Small, medium, large.



mici / small



medii / medium
50 µm
10 buc / pcs



mari cu bordură / large with ledge

Matrici conturate metalice secționale
Contoured metal matrices, sectional

10 1764-SEC



mici / small



medii / medium
50 µm
12 buc / pcs



mari / large

Matrici conturate metalice tip șă
Contoured metal matrices, saddle type

10 1764-TSA



mici / small
35 x 5 mm
(1.342)

12 buc / pcs



mari / large
6 x 0.05 mm
(1.343)

Matrici Pony metalice
Metallic Pony matrices

10 1552



mici / small
35 x 6 mm
(1.341)

12 buc / pcs



mari / large
7 x 0.05 mm
(1.344)

Matrici Pony metalice bombate
Metallic Pony matrices with ledge

10 1553



Clemă small

• Pentru aplicarea inelelor matricilor conturate tip șă

Small springclip

• For the application of contoured saddle matrices ring

500 1843



Inel simplu

• Pentru aplicarea matricilor conturate de tip șă

Simple ring

• For the application of contoured saddle matrices

500 1844



mici / small



medii / medium
50 buc / pcs



mari / large

Matrici conturate metalice secționale
Sectional contoured metal matrices

10 2271



pentru frontali / for fronts



pentru posteriori / for posterior

Cape celuloid transparente
Transparent celluloid capes

64 coroane / crowns

10 2116



3.2mm 6.4mm 6.4mm
100 buc/pungă - pcs/bag

Elastice intraorale

• Duritate medie / ridicată

Intraoral elastics

• Hardness medium / heavy

10 2132

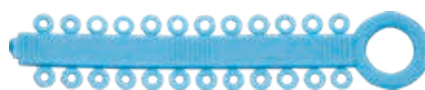

30 culori / colors
24 buc/baghetă - pcs/wand

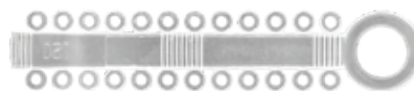

transparente / transparent
24 buc/baghetă - pcs/wand

Module elastice
Elastic modules

10 2133



transparente / transparent
4.6m



color / color
4.6m

Catene

• Cu spații

Chains

• With spaces

10 2134



mărimi / sizes:
 #1 / 4.0015 (0.035 mm × 6 mm)
 #3 / 16.0015 (0.035 mm × 5 mm)
 #1 / 4.002 (0.050 mm × 6 mm)
 #3 / 16.002 (0.050 mm × 5 mm)

lungime rolă / role length: 3 m
 1 rolă / roll

Rolă pentru realizarea matricilor, inox
Matrix roll, stainless steel

10 1390



100 buc / pcs 1.000 buc / pcs
 1 × 10 cm

Benzi de plastic (mylar) pentru realizarea matricilor, transparente

10 1189

• Acestea sunt rezistente la solvenți. Datorită rezistenței mari, nu se rup și nu se curbează.
Plastic (mylar) matrix strips, clear
 • They resist solvents, are very strong, will not stretch curl or break.

G013 Pene Fixare • Fixing Wedges



200 buc / pcs

Pene interdentare din lemn
Interdental wooden wedges

480 1358-200-AST



1.5 × 1.5 × 14 mm



1.3 × 1.5 × 13 mm



1.5 × 1.5 × 14 mm



1.3 × 1.5 × 16 mm



1.5 × 2.0 × 16 mm



1.3 × 2.0 × 14 mm

100 buc / pcs

Pene interdentare din lemn
Interdental wooden wedges

480 1358



XS (albastru / blue)
 17.6 × 1.1 mm



S (verde / green)
 17.8 × 2.1 mm



M (galben / yellow)
 17.8 × 2.45 mm



L (purpuriu / purple)
 17.8 × 2.8 mm

100 buc / pcs

Pene Poly interdentare cuinel
Interdental Poly wedges with hole

400 1200



20 x 2.0 mm
galben / yellow



20 x 2.5 mm
albastru / blue

40 buc / pcs

Pene interdentare elastice din silicon

Interdental rubber elastic wedges

100 1557

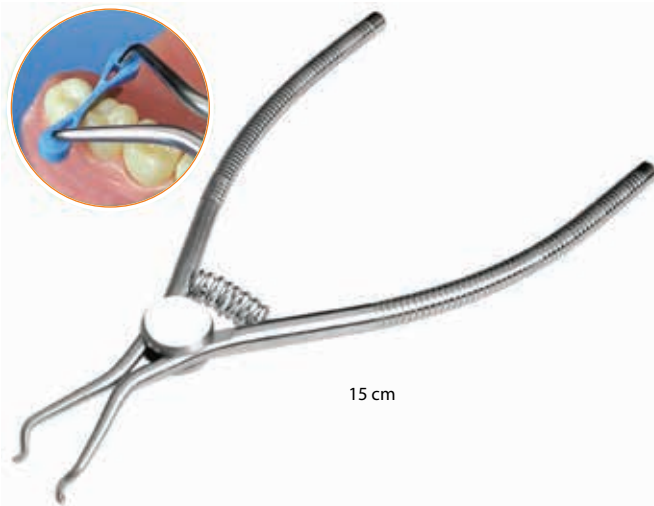

15 cm

Clește cu arc folosit pentru instalarea penelor interdentare elastice

Forceps with coil spring for installation of elastic wedges

200 1556

G053 Chiurete & Fuloare Inox • Bone Cutters & Filling Instruments Stainless Steel

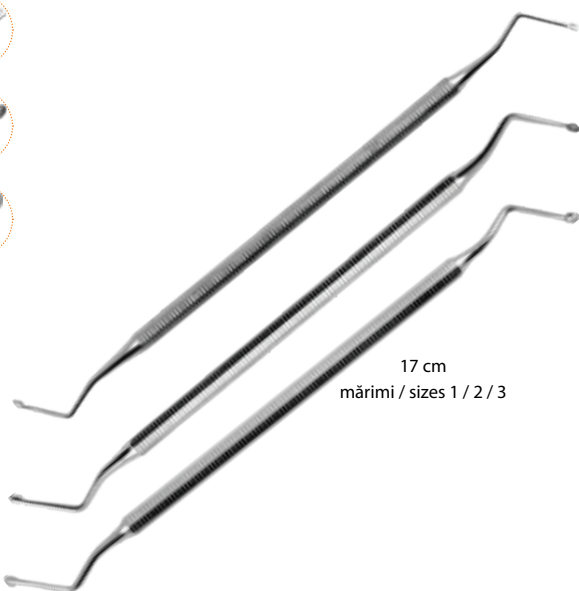

17 cm
mărimi / sizes 1 / 2 / 3

Chiuretă alveolară Hemingway, tip linguriță

Bone curettes Hemingway, spoon type

400 1268

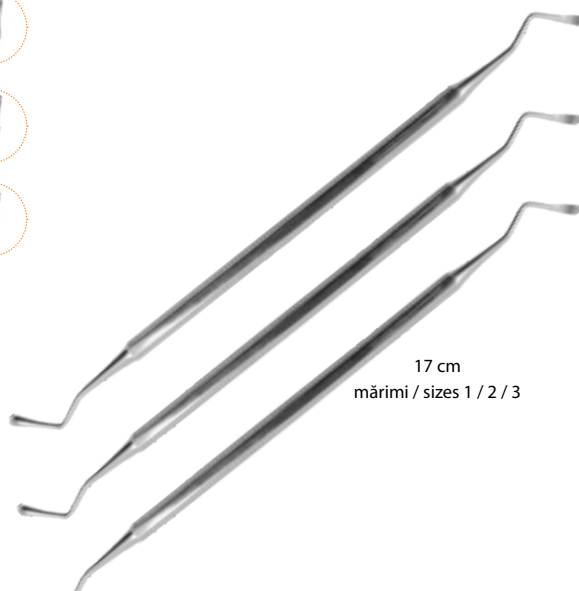

17 cm
mărimi / sizes 1 / 2 / 3

Chiuretă alveolară Lucas, tip excavator

Bone curettes Lucas, excavator type

400 1269

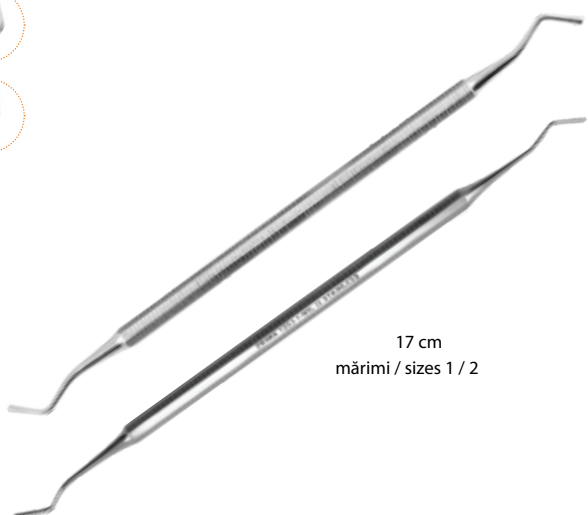

17 cm
mărimi / sizes 1 / 2

Fuloare - instrument de umplere Williams, amprentă rotundă dreaptă

Williams filling instruments, round straight imprint

400 1263-WIL

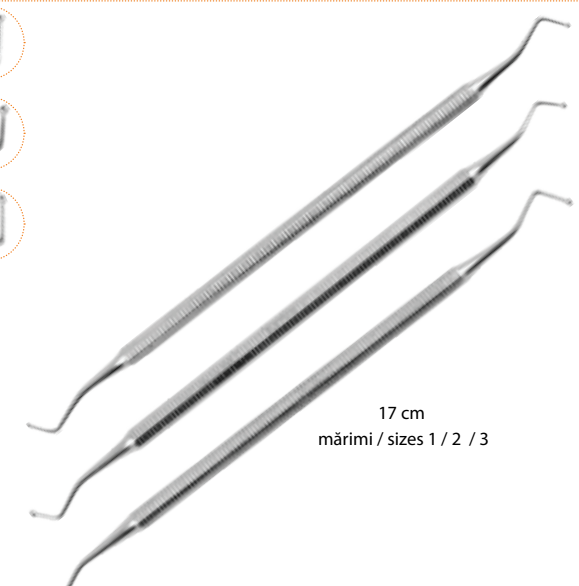

17 cm
mărimi / sizes 1 / 2 / 3

Fuloare - instrument de umplere Bila, amprentă sferică

Ball filling instrument, spherical imprint

400 1263-BIL



drept / straight



curb / curved



12cm

Pensă hemostatică Halstead Mosquito
Forceps Halstead Mosquito

100 1257



14cm

Foarfecă chirurgicală

• Dreaptă cu vârf bont

Surgical scissor

• Straight, with blunt end

140 1438



drept / straight



14cm

Foarfecă Castroviejo

• Pentru intervenții chirurgicale în microchirurgie

Scissors Castroviejo

• For surgical operations in microsurgery

150 1259



drept / straight



12cm

Foarfecă Iris

• Pentru intervenții chirurgicale în oftalmologie

Scissors Iris

• For surgical operations in eye surgery

150 1258



curb / curved



15.5 cm
inox / stainless steel

Pensă Adson

Adson dressing forceps

300 1780



curb / curved

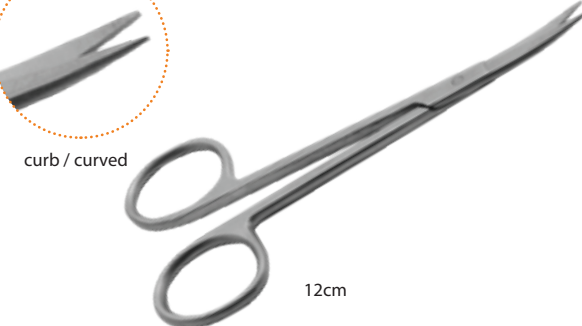

18.5 cm
inox / stainless steel

Pensă hemostatică Pean

Paen forceps

300 1778

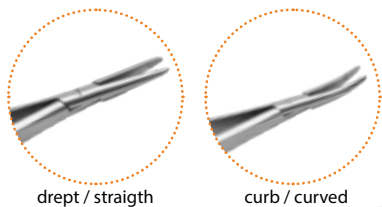

drept / straight

curb / curved

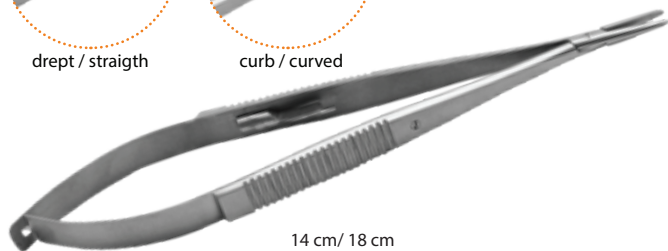

14 cm / 18 cm

Port ac Castraviejo

Needle holder Castraviejo

100 1260

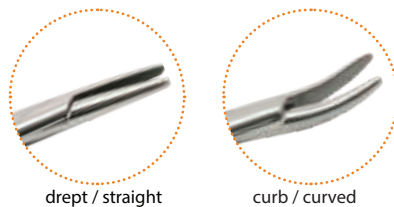

drept / straight

curb / curved

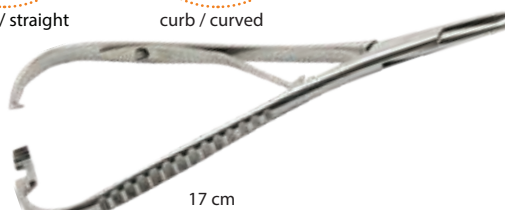

17 cm

Port ac Mathieu

Needle holder Mathieu

100 1261

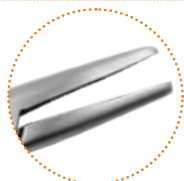

drept / straight



18 cm

Port ac Mayo Hegar

• Pentru acele de sutură

Needle holder Mayo Hegar

• For suture needles

80 1266



drept / straight



12 cm

Chiuretă alveolară dreaptă Williger

Bone curettes straight, Williger

500 2074



Pensă inox cu vârful ascuțite

Stainless steel London College dressing forceps with sharp tips

250 0913



9.5 x 4.5 x 0.5 cm

Spatulă bucală inox cu două capete

Stainless steel plastic filling instrument

500 0914



Sondă ascuțită inox

Stainless steel dental explorer

500 0915



Mâner pentru oglinzi inox

Stainless steel mirror handle

500 0657



Instrument manual de scos lucrări

• Cu bilă, 3 vârful

Manual tool for removing works

• With ball, 3 tips

10 2311



mărimi / sizes #4, #5
12 buc / pcs



Oglinzi dentare inox
Stainless steel dental mirrors

12 0618



Trusă stomatologică de consultație

12 0288

- Instrumente din oțel inox sterilizabile.
- Componentă trusă: pensă dentară, oglindă plană, mâner pentru oglindă, sondă dentară, spatulă bucală.

Dental consultation kit

- Sterilizable stainless steel instruments.
- Kit components: dental forceps, flat mirror, handle for mirror, dental-probe, mouth spatula.

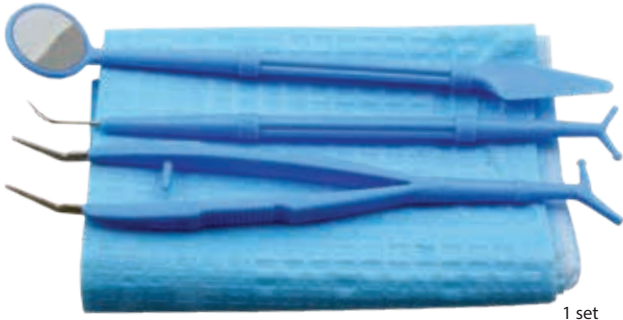

1 set

Trusă stomatologică de consultație de unică folosință, sterilă

50 1420-KIT-2

- Componente: spatulă plastic cu oglindă nr. 5, pensă dentară, sondă ascuțită, câmp de consultație, hârtie cu PE 50 x 50 cm.

Disposable dental consultation kit, sterile

- Kit components: mirror no. 5 with spatula handle, forceps, probe, waterproof towel tissue with PE 50 x 50 cm.



1 set

Trusă stomatologică de consultație de unică folosință, sterilă

600 1420-KIT-1

- Componente: spatulă plastic cu oglindă nr. 5, pensă dentară, sondă ascuțită.

Disposable dental consultation kit, sterile

- Kit components: spatula handle mirror no. 5, forceps, probe.

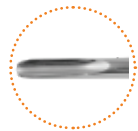

rotunjit / rounded

Elevator drept

- Instrument folosit pentru extracții dentare și ale resturilor radiculare, precum și în secționarea ligamentului circular alveolo-dentar.

Straight elevator

- Tool used for dental extractions and root debris and for cutting the circular alveolo-dental ligament.



ascuțit / sharp

50 1162



stânga / left

dreapta / right

rotunjit / rounded

Elevator curb
Curved elevator



stânga / left

dreapta / right

ascuțit / sharp

50 1163

Clește stomatologic

• Clește stomatologic pentru extracții. Medicul stomatolog alege cleștele de extracție adecvat pentru dintele ce urmează a fi îndepărtat. Cleștele trebuie să se potrivească anatomiei dintelui.

Dental forceps

• Forceps for dental extractions. The dentist chooses the right forcep for the tooth that is to be extracted. The forcep should go with the tooth anatomy.



Premolar superior
Upper premolar



Premolar inferior
Lower premolar



Molar superior stânga
Left upper molar



Molar superior dreapta
Right upper molar



Molar inferior
Lower molar



Molar de minte inferior
cu pinteni
Lower third molar with spurs



Al treilea molar superior
Third upper molar



Rădăcini superiori
Senior roots



Rădăcini inferiori
Lower roots



Incisivi superiori
Upper incisors



Clește stomatologic

• Clește stomatologic pentru extracții. Medicul stomatolog alege cleștele de extracție adecvat pentru dintele ce urmează a fi îndepărtat. Cleștele trebuie să se potrivească anatomiei dintelui.

Dental Forceps

• Forceps for dental extractions. The dentist chooses the right forcep for the tooth that is to be extracted. The forcep should go with the tooth anatomy.



Premolari superiori
Upper premolars

10 1026-561



Incisivi superiori
Upper incisors

10 1026-560

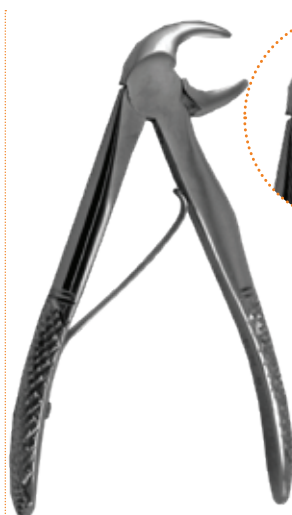

Incisivi inferiori
Inferior incisors

10 1026-565

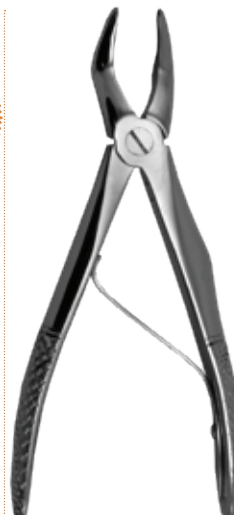

Molari superiori
Upper molars

10 1026-562



Rădăcini superioare
Upper roots

10 1026-563



Molari inferiori
Lower molars

10 1026-566

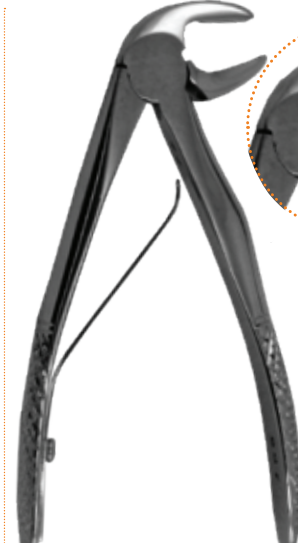

Rădăcini inferioare
Lower roots

10 1026-567

G340 Ciupitor de Os • Dental Rongeur



14 cm

ușor curbat / slightly curved

Ciupitor de os Friedman inox
Stainless steel Friedman rongeur

10 1418-FRI



14 cm

curbat la 90° / curved at 90°

Ciupitor de os Blumenthal
Stainless Steel Blumenthal rongeur

10 1418-BLT



08/10-15/40-45/80

Ace H-Files Hedstrom 300 0981

• Se utilizează la completarea lărgirii canalului radicular.
• 6 buc, 25 mm, oțel inox, asortate.

Hedstrom H-Files

• It is used to integrate the root canal enlargement.
• 6 pcs, 25 mm, stainless steel, assorted.

- 15
- 20
- 25
- 30
- 35
- 40



08/10-15/40-45/80

Ace K-Files Kerr 10 0629

• Pentru deschiderea și lărgirea canalelor radiculare.
• 6 buc, 25 mm, oțel inox, asortate.

Kerr K-Files

• For opening and enlarging root canals.
• 6 pcs, 25 mm, stainless steel, assorted.

- 15
- 20
- 25
- 30
- 35
- 40

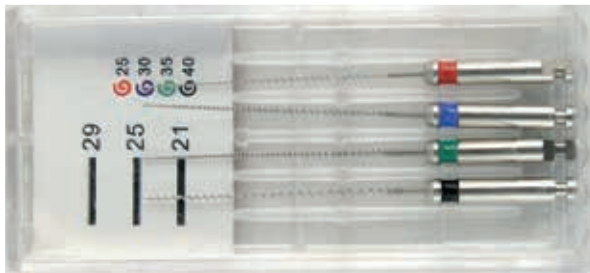
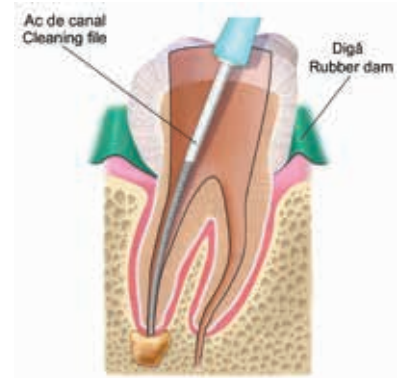

25-40

Ace Lentullo (Paste Carriers) 1200 0630

• Ace rotative cu formă conică folosite pentru introducerea pastei în canal.
• 4 buc, 25 mm, oțel inox, asortate.

Lentullo files (Paste Carriers)

• Conical rotary needles used for introducing the paste into the root canal.
• 4 pcs, 25 mm, stainless steel, assorted.

- ⊖ 25
- ⊖ 30
- ⊖ 35
- ⊖ 40

- ✱ 0
- ✱ 1
- ✱ 2
- ✱ 3
- ✱ 4
- ✱ 5
- ✱ 6
- ✱ 7
- ✱ 8
- ✱ 9



10-40

Ace Tire-Nerfs 450 0982

• 10 buc, 21 mm, oțel inox, asortate.

Tire-Nerfs files (Barbed Broaches)

• 10 pcs, 21 mm, stainless steel, assorted.

Ace Endo drepte pentru irigare canal dentar 500 1279

• 21 mm, oțel inox, asortate.

Irrigating Endo needles for root canal

• 21 mm, stainless steel, assorted.



2.5 cm
10 buc / pcs



Cutie sterilizare freze și ace, cu sită

• Din plastic, autoclavabilă

Sterilizable box for burs and dental needles

• Made of plastic, autoclavable

100 2021



D: 7 cm, H: 6.8 cm

Suport sterilizare ace

• Cu orificii de măsurare și burete.

Needle sterilization support

• With measuring holes and sponge.

10 1783



- 1 (Ø 1.00mm)
- 2 (Ø 1.20mm)
- 3 (Ø 1.35mm)
- 4 (Ø 1.50mm)



10 buc / pcs

Pivoți fibră de sticlă, radio opac
Radio opaque glass fibre posts

100 0344



Lungime 1,5 cm, diametru 5 mm.
1.5 cm length and 5 mm diameter.

Cheie pivoți endo, capăt în formă de cruce
Dental key for screw post, cross end

5000 1643



10 buc / pcs
lungime / length: S/M/L
grosime / tickness: 1/2/3/4

Pivoți endodontici oțel, inox aurit
Gold plated cross head screw posts

12 0341



10 buc / pcs
lungime / length: S/M/L
grosime / tickness: 1/2/3/4

Pivoți endodontici, titan
Titanium composite screw posts

12 0983



Ø1.0 mm



Ø1.2 mm



Ø1.4 mm

Freză cilindrică pentru pivoți endodontici
Cylindrical drill for endodontic posts

2000 2046



Ansa detartraj

• Supragingival și interdental, oțel inoxidabil, filet pe interior, compatibile cu EMS.

Scaler tip

• Supragingival and interdental G1, G2, G3, G4, stainless steel, intern screw, compatible with EMS.

20 1697



Ansa detartraj

• Endodontice curatare și irigare canal, oțel inoxidabil, filet pe interior, compatibil cu EMS.

Scaler tip

• Endodontic root canal cleaning and irrigation, stainless steel, intern screw, compatible with EMS.

20 1698



Ansa detartraj

• Periodontice, curatare și irigare subgingivala, oțel inoxidabil, filet pe interior, compatibil cu EMS.

Scaler tip

• Periodontic subgingival cleaning and irrigation P1, stainless steel, intern screw, compatible with EMS.

500 1699



universală / universal

Cheie Torque

Torque wrench

20 1633



Ansa detartraj

• Supragingival și interdental, oțel inoxidabil, filet pe interior, compatibile cu SATELEC.

Scaler tip

• Supragingival and interdental, stainless steel, intern screw, compatible with SATELEC.

500 1627



Ansa detartraj

• Periodontice, curatare și irigare subgingivală, oțel inoxidabil, filet pe interior, compatibil cu SATELEC.

Scaler tip

• Periodontic subgingival cleaning and irrigation, stainless steel, intern screw, compatible with SATELEC.

20 1631

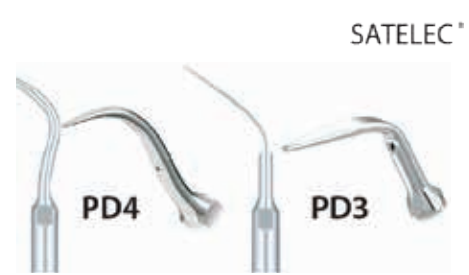

Ansa detartraj

• Periodontice, curățare și irigare subgingivală, oțel inoxidabil, filet pe interior, compatibil cu SATELEC.

Scaler tip

• Periodontic subgingival cleaning and irrigation, stainless steel, intern screw, compatible with SATELEC.

500 1632

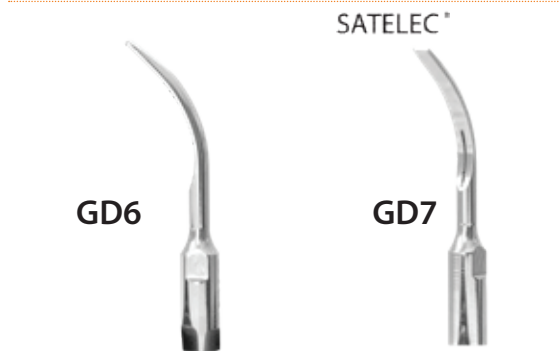

Ansa detartraj

• Supragingival și interdental, oțel inoxidabil, filet pe interior, compatibile cu SATELEC.

Scaler tip

• Supragingival and interdental, stainless steel, intern screw, compatible with SATELEC.

20 1628



Ansa detartraj

• Periodontice, curățare și irigare subgingivală, oțel inoxidabil, filet pe interior, compatibil cu SATELEC.

Scaler tip

• Periodontic subgingival cleaning and irrigation, stainless steel, intern screw, compatible with SATELEC.

20 1629



Ansa detartraj

• Periodontice, curatare și irigare subgingivală, oțel inoxidabil, filet pe interior, compatibil cu SATELEC.

Scaler tip

• Periodontic subgingival cleaning and irrigation, stainless steel, intern screw, compatible with SATELEC.

500 1630



10 buc / pcs
cupă / cup



Din păr natural capră, pentru piesa contraunghi
Made out of natural goat hair, for the contra-angle tool



Din nylon, pentru piesă contraunghi
Made out of nylon, for the contra-angle tool

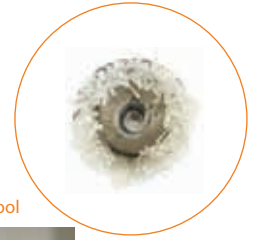

Periuțe profilaxie cupă

• Închidere prin blocare pentru piesa contraunghi (RA).

100 0977

Prophy brushes junior cup shape for polishing

• Latch closure for dental angle handpiece (RA).



10 buc / pcs

100 1250

Gume profilaxie lustruit cupă, albe (duritate medie)

• Cauciuc sintetic, închidere prin blocare pentru piesă contraunghi (RA).

Prophy rubber cups, white (medium)

• Latch closure for dental angle handpiece, junior cup shape for polishing.



10 buc / pcs

100 1467-LUS-CIR

Periuțe detartraj și lustruire circulară, nylon

• Închidere prin blocare pentru piesa contraunghi (RA).

Prophy brushes, nylon bristle

• Latch closure for dental angle handpiece, circular head shape for polishing.



10 buc / pcs

100 1467-LUS-INT

Periuțe detartraj și lustruire interdentară, nylon

• Închidere prin blocare pentru piesa contraunghi (RA).

Prophy brushes, nylon bristle

• Latch closure for dental angle handpiece, circular head shape for polishing.

flacon / bottle 500 ml

Gel de fluorizare

• Cu vitamina E

Fluoridation gel

• With vitamin E

10 2238



vanilie
vanilla



mentă
mint



cășuni
strawberries

2x 1.2ml seringa / syringe
5 aplicatoare / applicators



Tratament profesional gel de albire a dinților

10 2312

• Bicomponent pe baza de peroxid de hidrogen 40% și agent de activare pe baza de fluorura de sodiu și nitrat de potasiu

Professional teeth whitening gel treatment

• Bicomponent based on 40% hydrogen peroxide and activating agent based on sodium fluoride and potassium nitrate



2x 1.2ml seringa / syringe
2 aplicatoare / applicators

Material tip digă lichidă

100 2313

• Pentru izolarea gingiei pentru prevenirea riscului de iritație în timpul procedurilor stomatologice
• Albastră

Liquid dam material

• For gum isolation to prevent the risk of irritation during dental procedures
• Blue



100 g flacon / bottle



Pulbere de profilaxie pe baza de bicarbonat de sodiu

30 1484

• Pentru curățare cu airflow.

Prophy powder based on sodium bicarbonate

• For air polishing procedures.



300 g flacon / bottle

Pulbere de profilaxie pe baza de carbonat de calciu

10 1485

• Pentru curățare cu airflow.

Prophy powder based on calcium carbonate

• For air polishing procedures.

flacon / bottle 200 gr

Pulbere de profilaxie

10 2232

• Pe baza de Bicarbonat de Sodiu
• Pentru curățare cu airflow

Prophylaxy powder

• Based on Sodium Bicarbonate
• For air polishing procedures





50 ml flacon / bottle

granulație medie, portocaliu
cu aromă de portocală
medium grain, orange colour
with orange flavour

granulație mare, verde
cu aromă de mentă
course grain, green colour
with mint flavour



Pastă pentru profilaxie, fără fluoruri, tixotropice

- Pastă profilactică asigură în mod optim îndepărtarea plăcii bacteriene și a tartrului fără a afecta smalțul dintelui.
 - Proprietățile tixotropice ale pastei sunt dimensionate astfel încât să asigure o aplicare comodă în condițiile profilactice specifice.
 - Tixotropice.
 - Arome naturale, nu conține flor. Grad ridicat de acceptare de către pacient.
 - Indicații: îndepărtarea plăcii bacteriene și a tartrului dentar.
 - Instrucțiuni: Pentru rezultate superioare, folosiți o piesă de mână la turație mică, cupă de cauciuc, perie de detrartraj.
- Umpleți cupa de cauciuc / peria de detrartraj cu pastă și executați un periaj profesional pe suprafața fiecărui dinte.
Repetati procedura pentru tratamentul complet. Puteți folosi ața dentară fără ceară pentru îndepărtarea excesului de pastă.



12 1064



Prophylaxis paste, no fluoride, thixotropic

- Prophylactic paste optimally removes plaque and tartar without affecting tooth enamel.
 - Thixotropic properties of the paste are dimensioned in order to ensure an comfortable application under specific prophylactic conditions.
 - Thixotropic
 - Natural flavors, does not contain fluoride. High acceptance by patients.
 - Indications: removes dental plaque and tartar.
 - Instructions: For superior results use low speed handpiece, rubber cap, proph polishing brushes.
- Fill in the rubber cap/ proph polishing brushe with paste and execute a professional brushing on the surface of each tooth.
Repeat the procedure for complete treatment. You can use dental floss, without wax to remove excess paste.

G034 Igienă Dentară • Dental Hygiene



12 buc / pcs

Periuțe de dinți pentru adulți

- Cu peri din nylon, ambalate în blister.

Adult toothbrush

- With nylon hair, packed in blister.

24 0086



12 buc / pcs

Periuțe de dinți pentru copii

- Cu peri din nylon, ambalate în blister.

Children toothbrush

- With nylon hair, packed in blister.

24 0087

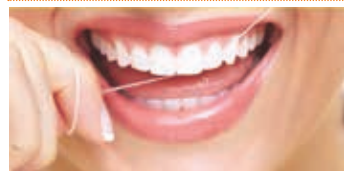

lungime / length 91,4 m

Ață dentară cu aromă de mentă

- Cauciuc sintetic, închidere prin blocare pentru piesă contraunghi (RA)

Dental floss with mint flavor

- Latch closure for dental angle handpiece, junior cup shape for polishing

20 1696



16 cm

Periuțe de dinți

- Cu peri din nylon, ambalaj flow pack, transparentă

Toothbrush

- packed in flow pack, transparent

100 0504



Noi culori disponibile
New colors available

78 x 83 x 45 mm

Cutie pentru pastrarea protezei dentare din plastic

• Culori: alb, galben, albastru, roz și roșu.

Plastic denture box

• Colours: white, yellow, blue, pink and red.

1722



1,000 buc / pcs

12



100 buc / pcs

120

Tablete pentru apă de gură cu aromă naturală de mentă

1066

• Este un antiseptic și participă cu succes la îndepărtarea plăcii bacteriene care determină apariția cariilor a gingivitelor și a respirației urât mirositoare. Pot fi de asemenea folosite pentru îndepărtarea particulelor de mâncare din cavitatea bucală. Se dizolvă o pastilă într-o jumătate de pahar cu apă caldă.

Mouthwash tablets with natural mint flavor

• An antiseptic that successfully participates in removing bacterial plaque that causes cavities, gingivitis and bad breath. It can also be used to remove food particles in the mouth. Dissolve one tablet in half a glass of warm water.



1 litru / liter

12



5 litri / liter

12

cu aromă de grapefruit și clorhexidină 0.2%
with grapefruit flavour and clorhexidine 0.2%



1 litru / liter

12



5 litri / liter

12

cu aromă de mentă și clorhexidină 0.12%
with mint flavour and clorhexidine 0.12%

Apă de gură

• Fără alcool. Nu se diluează pentru folosire. Împrospătează respirația, reduce placa bacteriană, iritațiile și inflamațiile gingivale.

Mouth wash solution

• Alcohol free. Do not dilute for use. Freshens breath, kills the bacterial plaque, reduces irritation and inflammation of the gums.

1205



250 ml

Acid citric 40%

12 1253

• Soluție pentru curățarea canalului radicular. Asigură curățarea precisă și obturarea corectă a canalelor. Îndepărtează stratul alunecos de pe peretele canalelor.

Citric acid 40%

• Solution for cleaning the root canal. Ensures the precise cleaning and the correct filling of the canals. Removes the slippery layer from the root canal wall.



50 ml

Eugenol

12 1063-UAB

• Antiseptic, analgezic, anti-inflamator local

Eugenol

• Local antiseptic & anesthetic



4 seringi / syringes x 4,3 g
20 vârfuri / tips, 1 cutie / box

10 0682-UAB

Acid demineralizant, acid fosforic 37%

• Pentru smalț și dentină.

37% Phosphoric acid etching gel

• For enamel and dentin.



50 ml



Aplicati soluția prin introducerea a câtorva picături în canal, folosind o seringă și apoi pompați soluția în canal cu un instrument de canal. Continuați instrumentarea canalului în timp ce este îmbibat cu soluție. Reaplicați când este necesar până ce curățarea și modelarea canalului este completă.

Apply by depositing a few drops into the root canal using a syringe, and then carefully pump the solution into the canal with a fine root canal instrument. Continue instrumentation of the canal while being soaked in the solution. Re-apply when necessary until canal shaping and cleaning is complete.

Soluție EDTA 17%

10 0627-UAB

• Pentru instrumentarea canalelor radiculare.

17% EDTA Solution

• Root canal preparation solution.



40 gr

Zinc oxide pudra

10 1309-UAB

• Pentru canalul radicular

Zinc Oxide powder

• For Root Canal



seringă / syringe 0.33 gr

Liner Ionosit fotopolimerizabil

20 1558-IONOSIT

• Pentru baza obturațiilor.

Ionosit Base liner

• For composite and amalgam restorations.



20 g pudră + 10 g lichid
20 g powder + 10 g liquid

i-BAS liner fotopolimerizabil

66 1558-UAB-IBAS

• Compomer pentru baza obturațiilor.

Base liner box

• For composite and amalgam restorations.



20 ml
flacon / bottle

Alustat

10 1640-UAB

• Soluție hemostatică, clorură de aluminiu

Alustat

• Liquid hemostatic solution, aluminium chloride



30 g borcan / jar

**Material pastă pentru obturații provizorii
Citodur**

Paste material for temporary Citodur fillings

10 2335



Riglă endodontică

- Cu marcaj în milimetri, din polimer ultra-performant
- Autoclavabilă, rezistentă la sterilizare chimică

10 2245

Endodontic ruler

- With millimeter marking, made of ultra-high performance polymer
- Autoclavable, resistance to chemical sterilization



**Substituent pentru Dentina Biodentine
Dentin substitute Biodentine**

10 2158



5 capsule / capsules

Compozit pentru restaurări provizorii

- Biacrilat 5:1, autopolimerizabil, culori A2, A3

Composite for temporary restorations

- 5:1 biacrylate, self-curing, colors A2, A3

10 2125



seringă / syringe 25 g



Dentine Conditioner

- soluție de acid poliacrilic 25% pentru îmbunătățirea aderenței restaurărilor cu ciment glassionomer

Tooth Cleanser (Dentine Conditioner)

- based upon a 25% solution of polyacrylic acid for enhances the adhesion of glass ionomer restoratives

20 2252



Light Cured Glaze

- Lac protector pentru protejarea suprafețelor captușite cu ciment glasionomer

Light Cured Glaze

- For the protection and enhancement of glass ionomer restorations

20 2251



Bonding adeziv monocomponent

• Pentru compozit și izomerii acestuia

Bonding Adhesive (single part)

• Light Cure for bonding composites and compomers

10 2255



30g pulbere / powder + 15ml lichid / liquid

Glasionomer

• Pentru cimentarea punților și coroanelor
• Particule sub 5 micrometri

Paste material for temporary Citodur fillings

• For seating crowns and bridges
• Particle size of less than 5 microns

10 2256



15g pulbere / powder + 7ml lichid / liquid

Glasionomer

• Pentru cimentare definitivă îmbunătățită cu rășină

Glass Ionomer

• Resin modified

10 2257



30 g

Ciment temporar

• De umplere obturații, pe bază de rășină

Temporary Cavity Filling Material

• Resin based

20 2258

Apă de gură concentrată

• Aromă de mentă, fără alcool și zahăr

mouthrise Concentrate

• Spearmint flavour, alcohol and sugar free

20 2261



100 ml



1 seringă / syringe × 5 g
5 vârfuri / tips, 1 cutie / box

i-Flow compozit fluid

• Pentru restaurațiile de Clasele III, IV, V, nuanțe A2, A3.

i-Flow Flowable composite

• For classes III, IV, V restoration, shades A2, A3.

6 0104-UAB



7 gr,
10 vârfuri / tips

Cement URC

• Ciment universal pentru pivoți pe bază de rășini

Cement URC

• Universal resin cement for fiber posts

10 2044



InFibra

• Șnur flexibil pentru ranforsare dentară, din polietilenă, pentru pivoți, punți, proteze

InFibra

• Flexible reinforcement ribbon for dental use, made of polyethylene, for dental posts, bridges, prostheses

105 2045



înălțime/height 1 tubular/1mm/2mm/3mm/4mm,
lungime/length 50 cm



000
negru
black

00
galben-negru
yellow-black

0
mov-alb
purple-white

1
albastru-alb
blue-white

2
verde-alb
green-white

Șnur de rețracție gingivală, neimpregnat
Gingival retraction cord, non-impregnated

210 1609

100% bumbac / cotton
244 cm



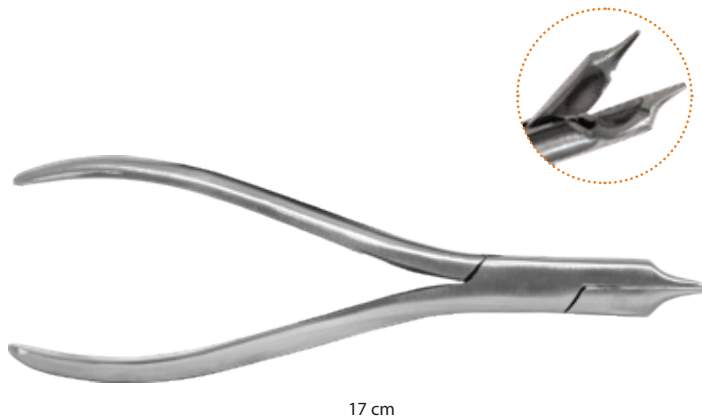

17 cm

Clește crampon

- Pentru realizarea crossetelor la proteze mobile si aparate ortodontice
- Inox

Crampon pincer

- For making crochet hooks for mobile prostheses and orthodontic appliances
- Stainless steel

10 2414



Instrument pentru măsurarea grosimii coroanelor din metal

- Autoclavabil
- Inox

Instrument for measuring the thickness of metal crowns

- Autoclavable
- Stainless steel

10 2310



Pasta de dinti multifect

- Îmbogătită cu nano particule de hidroxiapatită

Multi-effect toothpaste

- Powered by nano Hydroxyapatite

20 2346



Godeuri din plastic

- albastru, roz, verde; înaltime 23 mm, diametru intern 25mm
- set 300 bucăți

Plastic wells

- blue, pink, green, height 23 mm, internal diameter 25 mm
- set of 300 pcs

1 2383

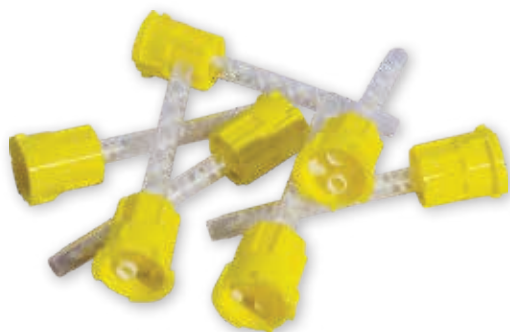

50 buc / pcs



Vârfuri de mixare 1:1

- Pentru mixarea materialelor de amprenta cu fluiditate medie
- Galbene

Mixing tips 1:1

- For mixing impression materials with medium fluidity
- Yellow

10 2359





diametru/diameter 5.4/6.5mm,
50 buc/pcs



Vârfuri de mixare intraorale 10 2359-NAT

- Natural
- Pentru materiale de amprentă

Intraoral mixing tips

- Natural
- For impression materials



Dispenser tip pistol pentru silicon de adiție
Addition silicone dispenser gun

10 1723

G017 Hârtie Articulații • Articulating Paper



100 μm - 12 seturi / sets x 12 foi / files
50 μm - 10 seturi / sets x 40 foi / files
30 μm - 10 seturi / sets x 40 foi / files

Hârtie articulație dreaptă

- Roșu-albastru, pentru ocluzii
- Straight articulating paper**
- Red-blue, for occlusions.

200 0980



100 μm - 6 seturi / sets x 12 foi / files
50 μm - 6 seturi / sets x 40 foi / files
30 μm - 6 seturi / sets x 40 foi / files

Hârtie articulație potcoavă

- Roșu-albastru, pentru ocluzii.
- Horseshoe articulating paper**
- Red-blue, for occlusions.

300 1093



mărimi / sizes S, M, L

Linguri plastic pentru material de impresie

400 1167

- Pereche superior & inferior.

Plastic impression trays

- Upper & lower pair.

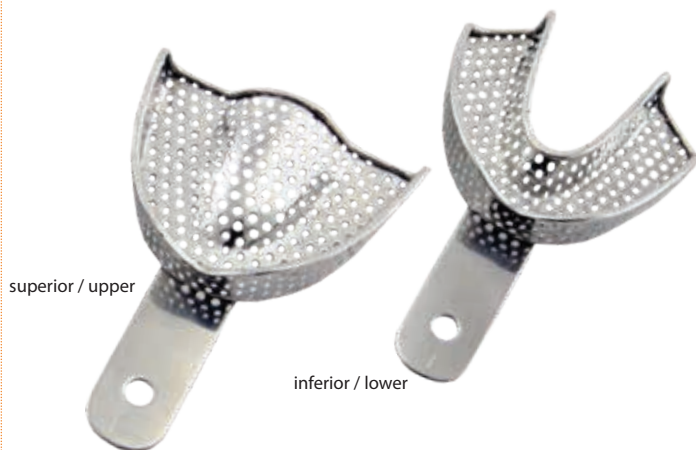

superior / upper

inferior / lower

mărimi / sizes S, M, L

Linguri inox pentru material de impresie

200 1423

- Pereche superior & inferior.

Stainless steel impression trays

- Upper & lower pair.



Linguri plastic pentru material de impresie

400 2226

- Pereche superior & inferior
- Pentru copii

Plastic impression trays

- Upper & lower pair
- For children



Linguri plastic pentru material de impresie

200 2126

- Semiarcadă pereche superior & inferior

Stainless steel impression trays

- Semi arcade upper & lower pair



lungime / length 150mm,
latime width 6mm,
1 față / front

Benzi abrazive

12 2227

- Inox
- Autoclavabile

Abrasive strips

- Stainless steel
- Autoclavable



Mandrină metalică

10 2215

- Pentru piesă cot
- Pentru discurile de finisare din hârtie cu inel metalic în mijloc

Metal mandrel

- For elbow piece
- For paper finishing discs with metal ring in the middle



roșu - conturare și finisare grosieră
red - contouring and gross reduction

verde - conturare și finisare
green - contouring and finishing

galben - finisare și polizare
yellow - finishing and polishing



Benzi abrazive pentru finisare și lustruire
Abrasive strips for finishing and polishing

25 buc / pcs

1200 1386



Ø 14 mm

albastru - finisare grosieră verde - conturare galben - finisare alb - lustruire
blue - gross reduction green - contouring yellow - finishing white - polishing
40 buc / pcs

Discuri de finisare și lustruire întregi cu manșon și ax
Polishing discs with stem and mandrel

400 1385-MAN



Ø 14 mm

albastru - finisare grosieră verde - conturare galben - finisare alb - lustruire
blue - gross reduction green - contouring yellow - finishing white - polishing
40 buc / pcs

Discuri de finisare și lustruire cu mandrină metalică
Polishing discs with metal bush

400 1385-MET

Discuri de finisare și lustruire
Polishing disks

400 1385-DISK



verde - conturare galben - finisare albastru - finisare grosieră alb - lustruire
green - contouring yellow - finishing blue - gross reduction white - polishing



12 buc / pcs

Stripuri îndepărtare tartaru
Tartar removal metal strips

• 1 margine neteda 1 margine striată, grosime 0.05 mm, 4 x 100 mm.
• 1 flat edge, 1 stripped edge, thickness 0.05mm, 4 x 100 mm.

200 1554

Stripuri metalice protecție

300 1762

• Pentru protecția dinților adiacenți împotriva accidentelor, lungime 50 mm, lățime 6 mm, grosime 0.06 mm.

Metal strips for protection

• For protection against accidental bur contact, 50 mm length, 6 mm wide, 0.06 thickness.



100 buc / pcs

Stripuri protecție dinți
Metal strips teeth protection

• Protecția dinților în cazul contactului cu freza, grosime 0.09 mm, 6 x 50 mm.
• Used to protect teeth in case of bur contact, thickness 0.09 mm, 6 x 50 mm.

500 1555

Stripuri metalice perforate profilactice

200 1763

• Pentru îndepărtarea tartrului, lungime 100 mm, lățime 4 mm, 0.05 mm grosime.

Perforated prophylactic metal strips

• For tartar removal, 100 mm length, 4 mm wide, 0.05 mm thickness.

G037 Compozit Universal • Universal Composite

Sistem de finisare în 3 pași. Gume pentru finisarea și lustruirea compomerilor, a glassionomerilor și a compozitelor universale. Acest sistem conține 3 tipuri de gume: conturare, finisare, lustruire.

3-step finishing system. Polishers for finishing and polishing compomers, glass ionomers and universal composites. This system contains 3 types of polishers: finishing, polishing.

Gume abrazive Coarse polishers



Size Ø x L mm	6.5 x 10	5 x 10	10 x 1
Viteză rotație / Rotation speed:	7500 – 10000 RPM		
Presiune / Pressure:	0.3 – 2 N		
Autoclavabil / Autoclavable:	135°C, 275°C		
Ax / Shank:	Oțel / Stainless steel		

Gume ultra fine Ultra fine polishers



Size Ø x L mm	6.5 x 10	5 x 10	10 x 1
Viteză rotație / Rotation speed:	3000 – 7500 RPM		
Presiune / Pressure:	0.3 – 2 N		
Autoclavabil / Autoclavable:	135°C, 275°C		
Ax / Shank:	Oțel / Stainless steel		

Gume medii Medium polishers



Size Ø x L mm	6.5 x 10	5 x 10	10 x 1
Viteză rotație / Rotation speed:	3000 – 7500 RPM		
Presiune / Pressure:	0.3 – 2 N		
Autoclavabil / Autoclavable:	135°C, 275°C		
Ax / Shank:	Oțel / Stainless steel		

Gume polizare compozit hibrid și universal Hybrid & universal composite polishers

10 1190

G038 Gume Polizare Restaurări • Polishers for Restorations

Pentru finisare & lustruire
Finishing & polishing



Gume polizare diamantate Diamond polishers

10 0952

G030 Gume Polizare Laborator • Laboratory Polishers

Sistem durabil, testat în timp. Suprafață precisă și abrazivă pentru o finisare mai rapidă.

Long lasting, time tested system. Firm sharp abrasive grit for a faster polishing finish.



Size Ø x L mm	12.5 x 22	10 x 18
---------------	-----------	---------

Viteză rotație / Rotation speed:	10000 – 15000 RPM	
Presiune / Pressure:	0.3 – 2 N	
Ax / Shank:	Oțel / Stainless steel	

Gume granulație medie Medium grit polishers

10 1642-GM

G039 Microumplură Compozit • Microfilled Composite

Sistem de finisare în 2 pași. Gume de cea mai bună calitate pentru toate tipurile de compozit microfil utilizate în reconstrucții. Se obține un lustru optim și de lungă durată. Acest sistem de finisare este util și în îndepărtarea resturilor de benzi ortodontice.

2-step finishing system. Best quality polishers for all types of microfil composite used in reconstructions. An optimal and long lasting luster is obtained. This finishing system is also useful in removing orthodontic strip remnants.

Gume ultra fine Ultra fine polishers



Size Ø x L mm	6.5 x 10	5 x 10
Viteză rotație / Rotation speed:	5000 – 7500 RPM	
Presiune / Pressure:	0.3 – 2 N	
Autoclavabil / Autoclavable:	135°C, 275°C	
Ax / Shank:	Oțel / Stainless steel	

Gume fine Fine polishers



Size Ø x L mm	6.5 x 10	5 x 10
Viteză rotație / Rotation speed:	7500 – 10000 RPM	
Presiune / Pressure:	0.3 – 2 N	
Autoclavabil / Autoclavable:	135°C, 275°C	
Ax / Shank:	Oțel / Stainless steel	

Gume polizare restaurări de microumplură Microfilled composite restoration polishers

10 1036

G040 Punți și Coroane • Crowns & Bridges

Sistem de finisare în 2 pași. Gumele sunt concepute pentru finisarea și lustruirea coroanelor și a punților din ceramică. Sunt specifice pentru finisarea marginilor din zirconiu și a punctelor de contact.

2-step finishing system. The polishers are designed for finishing and polishing crowns and ceramic bridges. They are specific for finishing zirconium edges and contact points.

Gume fine Fine polishers



Size Ø x L mm	6.5 x 10	5 x 10	10 x 1
Viteză rotație / Rotation speed:	10000 RPM		
Presiune / Pressure:	0.3 – 2 N		
Autoclavabil / Autoclavable:	135°C, 275°C		
Ax / Shank:	Oțel / Stainless steel		

Gume extra fine Extra fine polishers



Size Ø x L mm	6.5 x 10	5 x 10	10 x 1
Viteză rotație / Rotation speed:	5000 – 7500 RPM		
Presiune / Pressure:	0.3 – 2 N		
Autoclavabil / Autoclavable:	135°C, 275°C		
Ax / Shank:	Oțel / Stainless steel		

Gume polizare pentru coroane și punți Crowns and bridges polishers

10 1080



Cupă medie
Medium Cup

Glonț / Flacăra
Bullet / Flame

Disc / Pălărie
Disk / Hat





CC1558 5 buc / pcs

Freze extradure de turbină CC pentru tăiat coroane și punți
Extra hard crown cutting CC handpiece carbide burs

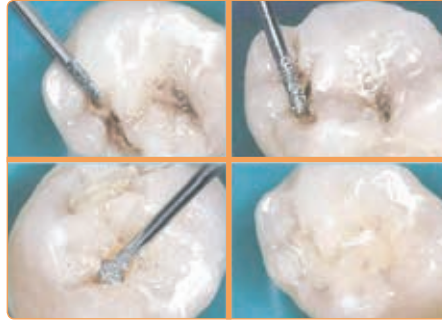

FG557, FG558 5 buc / pcs

Freze extradure pentru turbină FG - cilindrice
FG handpiece carbide burs - cylinder type



FG35, FG36 5 buc / pcs

Freze extradure pentru turbină FG- coninvers
FG handpiece carbide burs - inverted cone



FG700, FG701 5 buc / pcs

Freze extradure pentru turbină FG - efilate

FG handpiece carbide burs - straight



FG2, FG3, FG4, FG5, FG6 5 buc / pcs

Freze extradure pentru turbină FG - sferice

FG handpiece carbide burs - spherical



RA557, RA558 5 buc / pcs

Freze extradure pentru contraunghi RA - cilindrice

RA contra-angle handpiece carbide burs - cylinder type



RA35, RA36 5 buc / pcs

Freze extradure pentru contraunghi RA - con invers

RA contra-angle handpiece carbide burs - inverted cone



RA700, RA701 5 buc / pcs

Freze extradure pentru contraunghi RA - efilate

RA contra-angle handpiece carbide burs - straight



RA2, RA3, RA4, RA5, RA6 5 buc / pcs

Freze extradure pentru contraunghi RA - sferice

RA contra-angle handpiece carbide burs - spherical

G054 Freze Diamantate FG (Fricțiune) • Diamond FG (Friction Grip) Burs

	Formă Shape	Round
	Diametru cap Head diameter size	010, 012, 014, 017, 020
	Lungime Overall length	19 mm
	10 buc / pcs	10 1270-001
XF F M C XC		

	Formă Shape	Inverted Cone
	Diametru cap Head diameter size	014, 016, 019
	Lungime Overall length	19 mm
	10 buc / pcs	10 1270-010
XF F M C XC		

















	Formă Shape	Barrel
	Diametru cap Head diameter size	033
	Lungime Overall length	21 mm
	10 buc / pcs	10 1270-039
XF F M C XC		

	Formă Shape	Flat End Cylinder
	Diametru cap Head diameter size	010, 015
	Lungime Overall length	19 mm
	10 buc / pcs	10 1270-109
XF F M C XC		

	Formă Shape	Flat End Cylinder
	Diametru cap Head diameter size	014-M
	Lungime Overall length	19 mm
	10 buc / pcs	10 1270-110
XF F M C XC		

	Formă Shape	Flat End Cylinder
	Diametru cap Head diameter size	012, 014, 017
	Lungime Overall length	22 mm
	10 buc / pcs	10 1270-111
XF F M C XC		

G054 Freze Diamantate FG (Fricțiune) • Diamond FG (Friction Grip) Burs

 <p>Formă Shape</p> <p>Diametru cap Head diameter size</p> <p>Lungime Overall length</p> <p>10 buc / pcs</p> <p>XF F M C XC</p>	<p>Beveled Cylinder</p> <p>014</p> <p>22 mm</p> <p>10 1270-130</p>	 <p>Formă Shape</p> <p>Diametru cap Head diameter size</p> <p>Lungime Overall length</p> <p>10 buc / pcs</p> <p>XF F M C XC</p>	<p>Beveled Cylinder</p> <p>0125</p> <p>24 mm</p> <p>10 1270-131</p>	 <p>Formă Shape</p> <p>Diametru cap Head diameter size</p> <p>Lungime Overall length</p> <p>10 buc / pcs</p> <p>XF F M C XC</p>	<p>Round End Cylinder</p> <p>014</p> <p>22 mm</p> <p>10 1270-141</p>
 <p>Formă Shape</p> <p>Diametru cap Head diameter size</p> <p>Lungime Overall length</p> <p>10 buc / pcs</p> <p>XF F M C XC</p>	<p>Pointed Cone</p> <p>014, 016, 017, 019</p> <p>24 mm</p> <p>10 1270-166</p>	 <p>Formă Shape</p> <p>Diametru cap Head diameter size</p> <p>Lungime Overall length</p> <p>10 buc / pcs</p> <p>XF F M C XC</p>	<p>Pointed Cone</p> <p>014, 016</p> <p>20 mm</p> <p>10 1270-172</p>	 <p>Formă Shape</p> <p>Diametru cap Head diameter size</p> <p>Lungime Overall length</p> <p>10 buc / pcs</p> <p>XF F M C XC</p>	<p>Round End Taper</p> <p>016, 017</p> <p>22 mm</p> <p>10 1270-198</p>
 <p>Formă Shape</p> <p>Diametru cap Head diameter size</p> <p>Lungime Overall length</p> <p>10 buc / pcs</p> <p>XF F M C XC</p>	<p>Round End Taper</p> <p>012, 14, 16, 18</p> <p>21 mm</p> <p>10 1270-199</p>	 <p>Formă Shape</p> <p>Diametru cap Head diameter size</p> <p>Lungime Overall length</p> <p>10 buc / pcs</p> <p>XF F M C XC</p>	<p>Round End Taper</p> <p>016</p> <p>24 mm</p> <p>10 1270-200</p>	 <p>Formă Shape</p> <p>Diametru cap Head diameter size</p> <p>Lungime Overall length</p> <p>10 buc / pcs</p> <p>XF F M C XC</p>	<p>Pear</p> <p>014</p> <p>19 mm</p> <p>10 1270-234</p>
 <p>Formă Shape</p> <p>Diametru cap Head diameter size</p> <p>Lungime Overall length</p> <p>10 buc / pcs</p> <p>XF F M C XC</p>	<p>Flame</p> <p>014</p> <p>19 mm</p> <p>10 1270-247</p>	 <p>Formă Shape</p> <p>Diametru cap Head diameter size</p> <p>Lungime Overall length</p> <p>10 buc / pcs</p> <p>XF F M C XC</p>	<p>Flame</p> <p>012</p> <p>21 mm</p> <p>10 1270-248</p>	 <p>Formă Shape</p> <p>Diametru cap Head diameter size</p> <p>Lungime Overall length</p> <p>10 buc / pcs</p> <p>XF F M C XC</p>	<p>Flame</p> <p>010, 012, 014, 016</p> <p>22 mm</p> <p>10 1270-249</p>
 <p>Formă Shape</p> <p>Diametru cap Head diameter size</p> <p>Lungime Overall length</p> <p>10 buc / pcs</p> <p>XF F M C XC</p>	<p>Flame</p> <p>012, 014, 016</p> <p>24 mm</p> <p>10 1270-250</p>	 <p>Formă Shape</p> <p>Diametru cap Head diameter size</p> <p>Lungime Overall length</p> <p>10 buc / pcs</p> <p>XF F M C XC</p>	<p>Bud</p> <p>016, 018, 020, 023</p> <p>20 mm</p> <p>10 1270-257</p>	 <p>Formă Shape</p> <p>Diametru cap Head diameter size</p> <p>Lungime Overall length</p> <p>10 buc / pcs</p> <p>XF F M C XC</p>	<p>Torpedo</p> <p>014</p> <p>21 mm</p> <p>10 1270-289</p>
 <p>Formă Shape</p> <p>Diametru cap Head diameter size</p> <p>Lungime Overall length</p> <p>10 buc / pcs</p> <p>XF F M C XC</p>	<p>Gingival Curettage</p> <p>013, 014, 018</p> <p>21 mm</p> <p>10 1270-299</p>	 <p>Formă Shape</p> <p>Diametru cap Head diameter size</p> <p>Lungime Overall length</p> <p>10 buc / pcs</p> <p>XF F M C XC</p>	<p>Flame Needle</p> <p>010</p> <p>23 mm</p> <p>10 1270-540</p>		

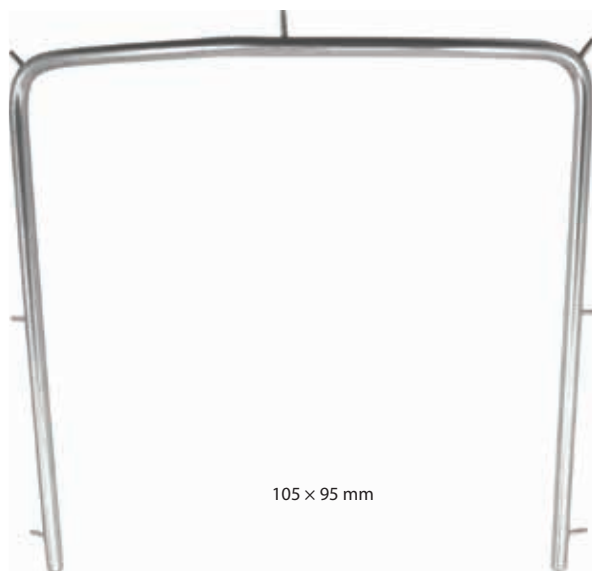

105 × 95 mm

Ramă digă inox

150 1267

- După așezarea foliei de digă și imobilizarea acesteia cu ajutorul clemelor, se aplică rama sistemului de digă. Se adaptează cauciucul, se perforază în dreptul pintenilor și apoi se poziționează și se trage spre exterior.
- Autoclavabilă, în formă de "U".
- Oferă un risc scăzut de infecție.

Stainless steel dental dam frame

- After placing the dental dam foil and immobilizing it using the clamps, apply the dental dam frame. Adapt the rubber, perforate it in the spurs, then position it and pull outwards.
- Autoclavable, "U" shaped.
- It offers a low risk of infection.



Clește aplicat cleme pentru digă, inox

50 1276

- Indicată pentru aplicarea și îndepărtarea clemelor de digă.
- Se prind clemele de digă cu ajutorul cleștelui, apoi se fixează pe dinte.

Stainless steel rubber dam clamp forceps

- Used for applying and removing the rubber dam clamps.
- Catch the rubber dam clamps with the forceps, then fix them on the tooth.



Clește Inox perforator pentru digă

30 1213

- Indicată pentru a perfora folia de digă.

Stainless steel dental dam hole puncher

- Indicate for perforation of the dental dam foil.

15 x 15 cm
36 buc / pcs

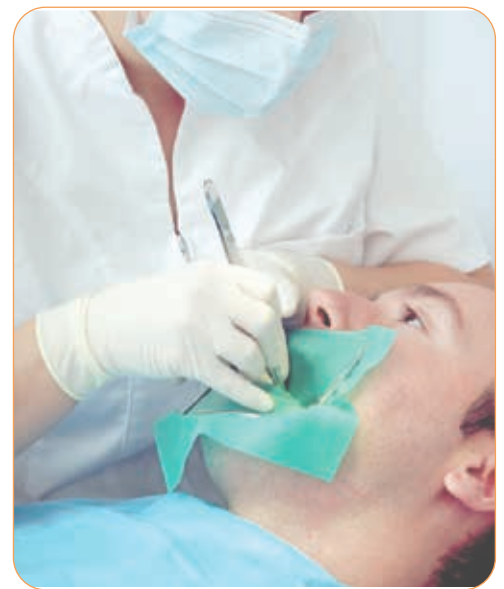
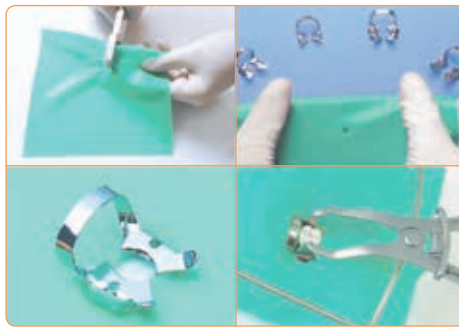

Diga latex mentolată, nepudrată

10 1223

- Foaie subțire de latex, care se prinde cu ajutorul unei de cleme de dinții pe care urmează să se efectueze tratamente dentare.
- O mai bună vizualizare a dintelui sau dinților care trebuie tratați. Oferind o culoare constantă de contrast, diga face ca dintele să fie mai vizibil pe toate părțile și astfel medicul dentist îl poate trata mai ușor. Păstrează dintele uscat. Previne înghițirea sau inhalarea resturilor de dinte asociate cu frezarea acestora. Protejează pacientul de la acțiunea iritantă a chimicalelor asociate cu tratamentele dentare. Protejează limba și obrajii pacientului de freza dentară. Ajută la izolarea dintelui împotriva bacteriilor din gură - acest aspect este important mai ales la tratamentele de canal (scoaterea nervului) și atunci când se aplică plombe foarte mari în cavități unde pulpa dentară este aproape. Poate calma pacientul. Cu diga pusă, senzația că medicul lucrează în gură dispare. Protejează medicul dentist și pe asistenta acestuia de orice boală pe care o poate avea pacientul. Oferă pacienților o calitate mai mare a restaurării dentare.

Dental dam, menthol, powder-free

- Thin sheet of latex which is attached with a clip on the teeth which will follow the dental treatments.
- A better view of the tooth or teeth which need to be treated. Offering a constant color contrast, the dental dam makes the tooth more visible on all sides, so your dentist can treat it easily. Keeps the tooth dry. Prevents tooth swallowing or inhaling debris associated with dental milling. Protects the patient from irritant action of chemicals associated with dental treatments. Protects the patient's tongue and cheeks against the dental drill. Helps isolate the tooth from bacteria in the mouth - this is especially important in root canal treatments (removal of the nerve), and when applied to very large fillings in cavities where pulp is close. It can calm the patient. With the dental dam on, the sensation of the doctor working in your mouth disappears. Protects the dentist and his assistant from any disease that the patient may have. Offers patients a higher quality of dental restorations.



#00
premolari inferiori și superiori,
dinți anteriori /
inferior and superior premolars,
front teeth



#1
premolari superiori /
superior premolars



#2
premolari și incisivi superiori /
premolars and superior incisors



#2A
premolari și incisivi /
premolars and incisors



#3
maxilar inferior, molari mici /
lower jaw, small molars



#4
molari superiori, dinți de lapte /
upper molars, milk teeth



#7
molar inferior, maxilar inferior /
lower molar, lower jaw



#8
molar superior /
superior molar



#8A
molar mici, parțial ieșiți, maxilar
inferior /
small molar, partially outward,
lower jaw



#9
dinți anteriori /
previous teeth



#12
maxilar superior, molari superi-
ori stânga /
upper jaw, upper left molars



#13A
maxilar superior, molari
superiori dreapta /
upper jaw, upper right molars



#14A
maxilar superior, molari mari,
parțial ieșiți /
upper jaw, large molars,
partially out

Clemă digă inox, premolari și molari

1000 1275

Cleme autoclavabile, metalice, mate, ce ajută la reducerea reflecțiilor de lumină în timpul procedurilor dentare. Pentru siguranță, prin orificiile acestora se poate introduce ață dentară și apoi ața va fi legată de ramă. Această măsură de siguranță protejează împotriva înghițirii clemei în cazul în care aceasta se va rupe.

Stainless steel rubber dam clamp, premolars and molars

Metal, matte, autoclavable clamps, which help to reduce light reflections during dental procedures.

For safety, dental floss can be introduced through their orifices and the floss will then be linked to the frame. This safety feature protects against swallowing the clamps in case they break.

Unit dentar
Dental Unit

2023



G400 Aparatură Stomatologică • Dental equipment



Turbină Torque Midwest LED cu generator WJ 1 1923

• Presiunea de lucru a capului de cuplu 0,25 MPA, viteza mai mare de 280,00 / min, diametrul capului 12,5 mm, înălțimea de 14,5 mm.

Torque Midwest LED handpiece with WJ generator

• Torque head working pressure 0.25 MPA, speed greater than 280,00/min, head diameter 12.5 mm, height 14.5 mm.

G020 Lubrifiant Turbine • Lubricants for Handpieces

Spray lubrifiant

• Pentru lubrifierea și curățarea turbinelor și a pieselor de mână

Dental Handpieces Oils Spray

• For the maintenance of handpieces and turbines



500 ml

• Lampa scialitică, negatoscop, sistem de alimentare cu apă distilată, pedală multifuncțională, scuipătoare din ceramică mobilă, scaun medic.

• Scialytic lamp, panoramaX-Ray film viewer, purified water supply system, multifunctional foot pedal, ceramic rotatable spittoon, doctor stool.

G415 Echipament cabinet • Medical equipment

Taburet tapițat
Upholstered stool

1 2077



piele ecologica / piele naturală
ecological leather / leather

- fără spătar
- reglabil pe înălțime
- 5 roți
- diametru șezut 40cm
- without backrest
- adjustable height
- 5 wheels
- seat diameter 40cm



1 ramă / frame + 1 ecran / shield
5 seturi / 5 sets

Ecran de protecție pentru ochi, unică folosință

• Ramă din polipropilenă, ecran din plastic, anti-ceață, economic.

Disposable eye shield

• Polypropylene frame, plastic shield, anti-fog, economical.

100 1401



10 buc / pcs

Folie transparentă pentru ecran protecție ochi, unică folosință

• Ecran din plastic, anti-ceață.

Disposable transparent eyewear shield

• Made of plastic, anti-fog.

300 1401-REZ



30 × 13.5 cm
10 buc / pcs

Ecran transparent pentru mască protecție ochi

• De unică folosință, din plastic, anti-ceață.

Disposable shield for face protection

• Made of plastic, anti-fog.

100 1402-REZ



28 × 19 cm
10 buc / pcs

Ecran transparent pentru mască protecție ochi

• De unică folosință, din plastic, anti-ceață

Disposable shield for face protection

• Made of plastic, anti-fog

100 1403-REZ



10 buc / pcs
30x13 cm

Ecran transparent

• Pentru mască protecție ochi, bandă autoadezivă, de unică folosință, din plastic, anti-ceață

Face protection shield

• Made of plastic, anti-fog, adhesive

32 2034



alb/roșu
white/red

Ochelari de protecție

• Anti-ceață și protecție UV

Glasses

• Anti-fog and UV protection

10 1726



25 × 17.5 cm
1 ramă + 10 ecrane
1 frame + 10 shields

Mască de protecție pentru față

• Ramă din policarbonat, ecran plastic, anti-ceață.

Face shield protection

• Frame made of polycarbonate, plastic shield, anti-fog.

32 1402



28 × 19 cm
1 ramă + 10 ecrane
1 frame + 10 shields

Mască de protecție pentru față

• Ramă din polipropilenă, ecran plastic, anti-ceață.

Face shield protection

• With frame made of polypropylene, plastic shield, anti-fog.

40 1403



500 buc / pcs 125 buc / pcs

Câmpuri PE + hârtie

• Câmpuri pentru consultație cu o suprafață plastifiată.

PE + paper dental bibs

• Bibs with a plastified surface for consultation.

1 0243



33 x 45 cm



alb / white, 7 x 9 x 43 cm
200 pcs / buc

Legături pentru bavete

• De unică folosință, autoadezive.

Bib holders

• Disposable, autoadhesive.

24 1471



albastru / blue



alb / white



metalic / metallic
42 cm

Lanț pentru bavete

• Ușor de utilizat, se folosește pentru prinderea bavetelor la gâtul pacientului.

Bib holder

• Easy to use, for catching the bibs at patient's neck.

100 1168

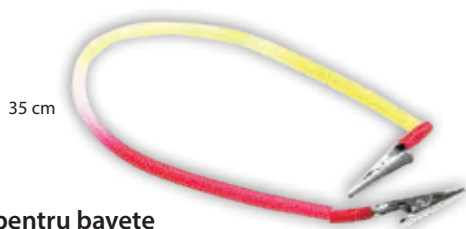

35 cm

Lanț pentru bavete

• Spirală, plastic

Bib holder

• Spiral, plastic

100 2094

Bavete polietilenă cu legături

• Impermeabilă.
• Pentru protejarea hainelor în timpul intervențiilor stomatologice.

Dental bibs with ties

• Waterproof.
• To protect clothes during dental procedures.

12 1246

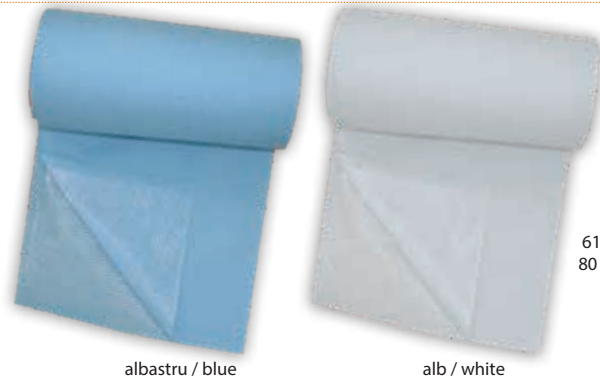

albastru / blue

alb / white

61 x 53 cm
80 buc / pcs

Bavete cu legături

• Din polietilenă cu hârtie embosată.
• Pentru protejarea hainelor în timpul intervențiilor stomatologice.

Dental bibs with ties

• Made of PE with embossed paper.
• To protect clothes during dental procedures.

15 0689



27 x 33 cm
2 straturi / ply
alb / white

175 buc / pcs

Acoperitor tetieră, hârtie + film PE

• Materialul este rezistent la murdărie.

Head rest covers, paper + PE film

• The material is stain resistant.

8 0688

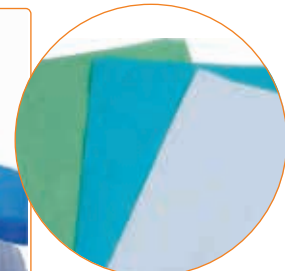

verde / green
albastru / blue
alb / white

Kit de protecție scaun stomatologic

• Tetieră, husă spătar, husă șezut și picioare. Din PPSB, mărime universală.

Disposable dentist chair cover

• Headrest, backrest, seat and leg cover. PPSB material, universal size.

50 1406



51 × 28 × 10 mm
200 buc / pcs

40

51 × 51 × 10 mm
180 buc / pcs

20

Plăcuță mixare din plastic

1363

• De unică folosință, economice, utilizând doar cantitatea necesară de material

Plastic mixing pads

• For single use only, Economical, using the exact quantity of material



Godeu din sticlă
Glass kappen

50 2249



3x3 cm

Recipient din sticlă
Glass recipient

10 1680



114 × 4 cm
100 buc / pcs

Bețișoare pentru mixare cu mâner lung, capăt lat și plat

70 1364

Mixing sticks with long handle, wide and flat tips



4.375 × 6.25 cm

100 buc / pcs

6.25 × 8.75 cm

100 buc / pcs

8.75 × 12.5 cm

100 buc / pcs

200

100

100

Paduri de mixare pentru compozit și materiale dentare

1251

• Din hârtie plastifiată.

Composite and dental materials mixing pads

• Made of plastic-coated paper.



18 cm

Spatulă pentru mixare ciment
Cement mixing spatula

300

1271



70 × 95 × 4 mm
3 godeuri / wells

70 × 90 × 4 mm
mată / matte

Plăcuță mixare din sticlă
Glass mixing pad

300

1278

Bol de mixare din PVC

1201

• Este folosit de către tehnicienii dentari. Produsele nu se lipesc de bol. Se poate șterge cu o cârpă umedă.

• Flexibil.

PVC mixing bowl

• Used by dental technicians. The products will not stick to this mixing bowl. Wipe with a wet cloth.

• Flexible.



130 × 96 mm
verde transparent /
clear green

100

105 × 57 mm
albastru transparent /
clear blue

180

86.5 × 51.6 mm
roșu transparent /
clear red

250

185 × 25 mm



roz / pink

albă / white

albastră / blue

Spatulă de mixare
Mixing spatula

50

1202



H355C190
(1.90 cm diametru / diameter)



H355C220
(2.20 cm diametru / diameter)



H333F300
(3 cm diametru / diameter)



H333F450
(4.50 cm diametru / diameter)

Disc diamantat flexibil
Sintered diamond discs

100 1732

Disc diamantat rigid
Plated diamond discs

100 1733



C79EFS104
F040



C79EFS104
F045

Freza extradură din carbid
Extra-hard carbide bur

100 1735



SHM 273-025



SHM 263-040



SHM 167-035

Freze diamantate
Diamond bur

100 1736



C364RE 103 010

C364RE 103 015

C364RE 103 023

Freza cilindrica din carbid cu varf drept pentru paralelogram
Cylindrical carbide cutter with straight edge for parallelogram

100 1734

cu burete

cu burete și pânză



8 cm diametru / diameter



Perie albă
White brush with sponge

100 1743



diametru / diameter 5cm
50 buc / pcs

Bureți pentru curățarea instrumentelor endodontice

10 1782

Sponges for endodontic instruments cleaning



culoarea / color A2

1 set



culoarea / color A3

Garnitură dinți

• Garnitura 28 de dinți acrilat 2 straturi, rotunzi, marimea M32.

Tooth gasket

• Acrylic Teeth, 28 pieces 2 layers, round, size M32.

100 1730



culoarea / color A2

1 set



culoarea / color A3

Garnitură dinți

• Garnitura 28 de dinți acrilat 3 straturi, rotunzi, marimea M32.

Tooth gasket

• Acrylic Teeth, 28 pieces 3 layers, round, size M32.

100 1731



Pensule din par negru Kolinsky

Kolinsky build-up brushes

10 1740



Ceară roz tip plăci

• Duritate mare.

Pink base plate wax

• Hard.

2.5 kg
1 cutie / box

50 1746





500 g

Material de amprenta pe baza de alginat
Alginate impression material

50 1737



453 g

Alginat precizie superioară pentru amprente
Dental high precision Alginate

• Cu indicator de fază cromatic. Cu aromă de vanilie și mentă.
 • With chromatic phase indicator. Vanilla and mint aroma.

10 1636



5 gr/plic, 5 plicuri/cutie
 5 gr/envelope, 5 packets/box

Praf concentrat pentru curățarea protezelor
Concentrated dental appliance cleaner

50 1738



Praf concentrat pentru curățarea protezelor

• Cu aroma de mentă.

Concentrated dental appliance cleaner

• With mint flavor.

5 2319



5 cm x 18 m

Benzi de captușire pentru ambalare din celuloză
Strips for packing from cellulose

10 1744



Nr. 2 - 2 cm
 100 buc / pc

Pini dentari
 • Oțel-inox auriți, fără ac.

Dental pins
 • Stainless steel, without needle.

50 1739



50 buc / pcs

Placi de bază fotopolimerizabile roz
Pink dental base plates

50 1741



75 ml

Spray ocluzie dentară

• Folosit pentru marcarea punctelor de contact la coroane și punți, verde.

Dental occlusion spray

• Used for visualising contact points on crowns and bridges, green.

10 1658

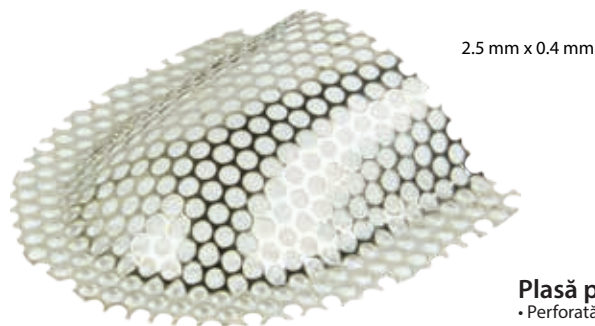

2.5 mm x 0.4 mm



Plasă proteze Dentaurem

• Perforată, din oțel inoxidabil, pentru ranforsarea protezelor superioare acrilice.

1000 1659

Dentaurem grid strengthener

• Perforated, made of stainless steel, for ensuring a strong denture base.



16 cm

Instrument modelat ceară pentru proteze

• Oțel inoxidabil.

Dental beale carver wax spatula

• Stainless steel.

10 1648

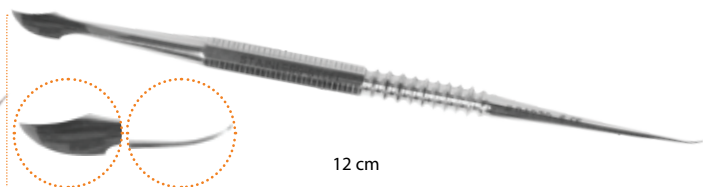

12 cm

Instrument scurt modelat ceară și gravat ghips

• Oțel inoxidabil.

Short wax carving dental instrument

• Stainless steel.

10 1649



17 cm

Instrument modelat ceară Le Cron

• Oțel inoxidabil.

Le Cron wax carving instrument

• Stainless steel.

10 1637

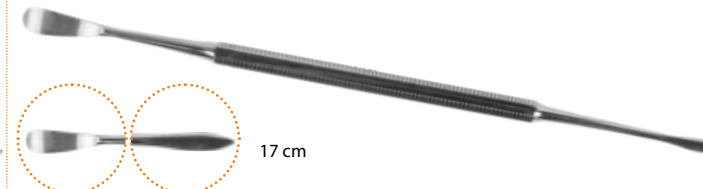

17 cm

Picurator ceară

• Oțel inoxidabil.

Dental wax dropper

• Stainless steel.

10 1650



6 x 24 mm

Polipant nemontat, tip cilindru

• Alb / maro / verde.

Flexible cylindrical polisher

• White / maroon / green.

1000 1645



3 x 21 mm

Polipant nemontat, lenticular

• Alb / maro / verde.

Flexible lenticular polisher

• White / maroon / green.

1000 1646



3 x 23 mm

Polipant nemontat, tip roată

• Alb / maro / negru.

Flexible disc polisher

• White / maroon / black.

1000 1647



12 cm

Suport profesional lucrări ceramice

• Oțel inoxidabil.

Professional support for dental ceramics

• Stainless steel.

50 1651

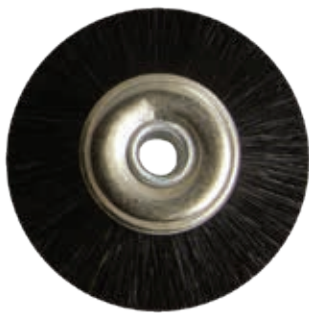

49 mm diametru / diameter

Perie neagră foarte rigidă pentru lustruire proteze acrilate și metal 500 1660

Single row slimline black lathe brush for polishing denture acrylics



49 mm diametru / diameter

Perie albă foarte fină pentru lustruire proteze acrilate și metal 500 1661

Single row slimline white lathe brush for polishing denture acrylics



54 x 23 x 3 mm

Perie cu fire de sârmă curățat freze 500 1662

Dental burs cleaning brush



25 mm diametru / diameter

Perie circulara din bumbac pentru lustruire proteze 500 1663

Cotton brush for polishing denture acrylics

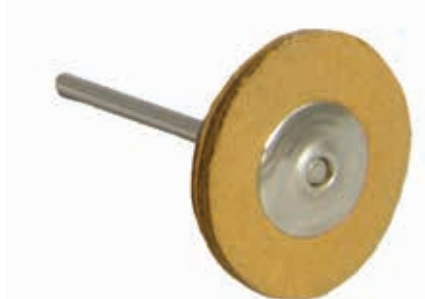

25 mm diametru / diameter

Perie circulară din piele de caprioară pentru lustruire proteze 500 1664

Deerskin polishing brush



23 mm diametru / diameter

Puf din bumbac nemontat pentru lustruire proteze 500 1665

Cotton yarn polishing brush



2 cm diametru / diameter
3 mm grosime / thickness

Piastră roz nemontată 1000 1742

Pink unmounted wheel shaped stone



7.5 cm diametru / diameter
0.5 cm grosime / thickness

Polipant maro, nemontat, tip roată subțire 100 1745

Rubberized abrasive wheel



**VETRO
DESIGN**

Str. C-tin Dragan no. 20, sector 3
032855 Bucharest, ROMANIA

vetro@vetro.ro
+40 738 976704
www.vetro.ro

www.prima-info.ro

**DENTAL
MEDICAL
LABORATORY
COSMETICS
VETERINARY**



Calendar 2022

IANUARIE

L	M	M	J	V	S	D
					1	2
3	4	5	6	7	8	9
10	11	12	13	14	15	16
17	18	19	20	21	22	23
24	25	26	27	28	29	30
31						

FEBRUARIE

L	M	M	J	V	S	D
	1	2	3	4	5	6
7	8	9	10	11	12	13
14	15	16	17	18	19	20
21	22	23	24	25	26	27
28						

MARTIE

L	M	M	J	V	S	D
	1	2	3	4	5	6
7	8	9	10	11	12	13
14	15	16	17	18	19	20
21	22	23	24	25	26	27
28	29	30	31			

APRILIE

L	M	M	J	V	S	D
				1	2	3
4	5	6	7	8	9	10
11	12	13	14	15	16	17
18	19	20	21	22	23	24
25	26	27	28	29	30	

MAI

L	M	M	J	V	S	D
						1
2	3	4	5	6	7	8
9	10	11	12	13	14	15
16	17	18	19	20	21	22
23	24	25	26	27	28	29
30	31					

IUNIE

L	M	M	J	V	S	D
			1	2	3	4
5	6	7	8	9	10	11
12	13	14	15	16	17	18
19	20	21	22	23	24	25
26	27	28	29	30		

IULIE

L	M	M	J	V	S	D
					1	2
3	4	5	6	7	8	9
10	11	12	13	14	15	16
17	18	19	20	21	22	23
24	25	26	27	28	29	30
31						

AUGUST

L	M	M	J	V	S	D
					1	2
3	4	5	6	7	8	9
10	11	12	13	14	15	16
17	18	19	20	21	22	23
24	25	26	27	28	29	30
31						

SEPTEMBRIE

L	M	M	J	V	S	D
			1	2	3	4
5	6	7	8	9	10	11
12	13	14	15	16	17	18
19	20	21	22	23	24	25
26	27	28	29	30		

OCTOMBRIE

L	M	M	J	V	S	D
						1
					2	3
4	5	6	7	8	9	10
11	12	13	14	15	16	17
18	19	20	21	22	23	24
25	26	27	28	29	30	31

NOIEMBRIE

L	M	M	J	V	S	D
						1
					2	3
4	5	6	7	8	9	10
11	12	13	14	15	16	17
18	19	20	21	22	23	24
25	26	27	28	29	30	

DECEMBRIE

L	M	M	J	V	S	D
			1	2	3	4
5	6	7	8	9	10	11
12	13	14	15	16	17	18
19	20	21	22	23	24	25
26	27	28	29	30	31	

Pozele prezentate în acest catalog au un caracter informativ și nu creează informații contractuale, întrucât designul produselor poate varia și pot exista diferențe între acestea și produsele existente la un moment dat în stoc!

The pictures presented in this catalog are for illustration purpose only and do not create contractual obligations because the design of the products may vary and there may be differences between them and the existing products in stock!